



Response to Inspectors Questions in Relation to Noise

Minerals and Waste Joint Plan for North Yorkshire County Council, the City of York Council and North York Moors National Park Authority



For UKOOG

Report No. JAT10840-REPT-01-R1

11 January 2019

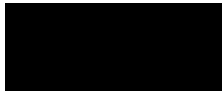

Quality Management

Prepared by:	Simon Stephenson CEng, BSc (Hons), MIOA, ASA	Technical Director		11 January 2019
Reviewed & checked by:	Phil Evans BSc (Hons) MSc, FGS MIOA, ASA	Senior Director - Acoustics		11 January 2019
Authorised by:	Simon Stephenson CEng, BSc (Hons), MIOA, ASA	Technical Director		11 January 2019
Report number:	JAT10840-REPT-01-R1		Date of issue:	11/01/2019

Revision History				
Rev	Date	Status	Reason for revision	Additional comments
0	10/01/2018	Issued for comment	-	-
1	11/01/2018	Issued	-	-

DISCLAIMER

RPS has used reasonable skill and care in completing this work and preparing this report, within the terms of its brief and contract and taking account of the resources devoted to it by agreement with the client. We disclaim any responsibility to the client and others in respect of any matters outside the stated scope. This report is confidential to the client and we accept no responsibility to third parties to whom this report, or any part thereof, is made known. The opinions and interpretations presented in this report represent our reasonable technical interpretation of the data made available to us. RPS accepts no responsibility for data provided by other bodies and no legal liability arising from the use by other persons of data or opinions contained in this report.

Except for the provision of professional services on a fee basis, RPS does not have a commercial arrangement with any other person or company involved in the interests that are the subject of this report.

COPYRIGHT © RPS

The material presented in this report is confidential. This report has been prepared for the exclusive use of the client and shall not be distributed or made available to any other company or person without the knowledge and written consent of the client or RPS.

Contents

1	Introduction.....	4
2	Acoustic Concepts and Terminology.....	7
3	Summary of Relevant Policy, Guidance and Standards.....	10
	Consideration of Relevant Appeal Decisions.....	19
	Summary of Policy, Standards and Guidance to be Applied to Assessing Noise Impact due to the Oil and Gas Development	21
4	Typical Sound Power Levels for Different Phases of Onshore Oil and Gas Development	22
	Construction and Traffic	22
	Drilling	22
	Well Workovers.....	24
	Hydraulic Fracture Stimulation.....	25
	Flow Testing and Well Appraisal.....	26
5	Typical Noise Levels at Noise Sensitive Receptors for Different Phases of Onshore Oil and Gas Exploration and Appraisal.....	28
	Methodology	28
	Noise Modelling Results for Typical Scenarios	28
6	Examples of Mitigation.....	34
	Approach	34
	Hydraulic Power Unit.....	34
	Mud Pumps	35
	Generators.....	36
	Shale shakers.....	36
	Centrifuge.....	37
	Acoustic screening.....	37

Draw-works 39

Top drive..... 39

Full rig enclosure 40

Fracking pumps 40

Flaring..... 40

Innovation..... 42

7 Noise Characteristics (Tonality, Impulsivity and Low Frequency Noise) 44

Tonality 44

Impulsivity 44

Use of ‘C’ Weighting 44

8 Response to Joint Plan Authorities’ Supplementary Note to Inspector 46

9 Summary and Conclusions..... 48

References

Tables, Figures and Appendices

Tables

Table 1.1:	Glossary of terms	5
Table 3.1:	Noise Exposure Hierarchy Based On the Likely Average Response	13
Table 3.2:	Summary of Observed Health Effects in the Population (WHO NNG).....	17
Table 4.1:	Sound power level data for drilling rigs, dBA re 1 pW	23
Table 4.2:	Sound power level data for workover / well intervention, dBA re 1 pW	25
Table 4.3:	Sound power level data for on load fracking equipment, dBA re 1 pW	25
Table 4.4:	Sound power levels of flares, dB re 1 pW	27
Table 5.1:	Noise modelling results for generic scenarios (drilling and workover, compared to 42 dB L _{Aeq,1h} threshold for night-time operations)	29
Table 5.2:	Noise modelling results for generic scenarios (hydraulic fracturing, compared to 55 dB L _{Aeq,1h} threshold for daytime operations).....	30
Table 5.3:	Noise modelling results for generic scenarios (appraisal, compared to 42 dB L _{Aeq,1h} threshold for night-time operations)	32
Table 9.1:	Boldon Rig 92 source sound power levels used in assessment, dB re 1 pW	50
Table 9.2:	Octave band sound power level data for Marriott HH-220 rig, dB re 1 pW.....	52
Table 9.3:	Octave band sound power level data for DrillTec VDD 370 rig, dB re 1 pW	54
Table 9.4:	Octave band sound power level data for rig T-49, dB re 1 pW	56
Table 9.5:	Octave band sound power level data for T-208, dB re 1 pW	57

Figures

Figure 2.1	Refraction of sound waves due to wind gradients (increasing wind speed with height)
Figure 5.1:	Noise monitoring during fracking at Preston New Road
Figure 5.2:	Noise monitoring during flaring at Preston New Road
Figure 6.1:	Temporary acoustic enclosure for HPU
Figure 6.2:	Mud pump engine enclosure (note exhaust silencers)
Figure 6.3:	Example mud pump housing
Figure 6.4:	Example generator enclosure with high specification exhaust silencers
Figure 6.5:	Example centrifuge enclosure
Figure 6.6:	Example demountable acoustic barrier
Figure 6.7:	Example barrier constructed from containers
Figure 6.8:	Example top drive enclosure
Figure 6.9:	Example frac pump enclosure
Figure 6.10:	Example enclosed ground flare

Appendices

Appendix A: Detailed Noise Data for Drilling Rigs

1 Introduction

1.1 RPS Group has been commissioned by United Kingdom Onshore Oil and Gas (UKOOG) to prepare technical evidence in response to specific questions in relation to noise asked by the Inspector as part of the Examination for the Minerals and Waste Joint Plan for North Yorkshire County Council, the City of York Council and North York Moors National Park Authority and this report provides a response to those questions.

1.2 Specifically, this report deals with the noise matters raised in the Inspector's questions 12, 13, 14 and 15, as follows:

"12. Is there any potential for reducing operational impacts such as by using radically quieter machinery or by using different working practices? For example, I understand that the sound power levels of dump trucks have reduced significantly in recent years. Are there any less noisy materials on the horizon for drilling (eg the use of ceramics) or any radically new technology (changes in drilling techniques or generator technology)? What is the reason for the height of drilling rigs? Is there potential for shortening them?"

13. Would the industry produce details of typical mitigation measures that might be employed to reduce the main impacts of development on receptors and with what potential effects? Whilst I appreciate that the application stage is the time for producing detailed assessments, it is nonetheless important at this stage to understand whether, in principle, there is potential for development to be made acceptable within this 500m zone.

14. Using typical scenarios, would the industry provide a brief technical assessment (explained in lay persons terms) of the potential range of noise impacts both with and without mitigation and at various distances from Noise Sensitive Receptors for the various stages of development and for the main noise sources. How would this test against national policy/guidance?"

15. The above should include a range of typical sound power levels for typical plant and machinery and how this converts to sound pressure levels at various distances under typical conditions. Tonality, impulsivity, issues over mitigating low frequency/long wavelengths should be addressed. Besides "A" weighted sound pressure levels, I would like to know whether and in what circumstances "C" weighted sound pressure levels should be used and how this affects measurements. Cumulative effects should be covered. I am also interested in flaring, light pollution and odour. Reference should be made to typical timescales for development phases; typical working hours for these phases; and typical levels of lorry movements."

1.3 In preparing this report, it has been assumed that the Inspector is primarily concerned with industry specific sources of noise as opposed to sources of noise which are features of other industries. Examples would be during construction and restoration phases of development which are similar

to sources of noise used in construction activities in most industries, including other minerals extraction (quarries, landfill etc.), industrial and commercial development and residential development. Traffic and operational noise are other examples.

1.4 This report has been prepared primarily in response to matters raised by the inspector. The structure of the report is as set out below:

- **Section 2** provides a layman's explanation of some fundamentals of acoustics and terminology used within this report.
- **Section 3** provides a background and context by summarising relevant policy, standards and guidance.
- **Section 4** outlines the sound power levels of typical equipment used at different phases of development (Inspector's questions 14 and 15).
- **Section 5** provides a bespoke review conducted by RPS using typical worst case scenario conditions against standard equipment with and without mitigation (Inspector's questions 14 and 15).
- **Section 6** outlines typical mitigation options available to the industry and a discussion of how the industry adapts and innovates (Inspector's questions 12 and 13).
- **Section 7** responds to some of the other technical issues raised by the Inspector in relation to tonality, impulsivity and low frequency noise (Inspector's question 15).
- **Section 8** offers a response to the Joint Authorities supplementary note on the proposed 500 m buffer zone.
- **Section 9** summarises the findings from the study and draws conclusions.

1.5 Table 1.1 presents relevant abbreviations used in this report.

Table 1.1: Glossary of terms

Abbreviation	Description
BPM	Best practicable means
BS	British Standard
dB	Decibel (unit of measurement for sound)
dBA	A-weighted decibel (unit of measurement for sound with a weighting filter applied to approximate the frequency response of the human ear at relatively low sound levels)
dBC	C-weighted decibel (unit of measurement for sound with a weighting filter applied to approximate the frequency response of the human ear at higher sound levels)
HPU	Hydraulic power unit
rpm	Revolutions per minute (rotational speed)
L _{A90}	A-weighted sound pressure level at 90 th percentile (level exceeded for 90% of the measurement duration) – representing the underlying noise level
L _{Aeq,T}	A-weighted equivalent sound pressure level (over defined time period, T)

Abbreviation	Description
L _{Amax}	Maximum A-weighted sound pressure level
L _{den}	Yearly averaged day-evening-night-weighted sound pressure level
L _{night}	Yearly averaged sound pressure level over the night-time period excluding the effects of a façade
L _p	Sound pressure level
L _w	Sound power level
m	Meter (unit of length)
mmscfd	Million standard cubic feet per day (unit for measurement of gas flow during flaring)
NNG	Night noise guidelines (issued by World Health Organisation)
PPG-M	Planning Practice Guidance (Minerals)
pW	Pico Watt – reference unit for sound power
UKOOG	United Kingdom Onshore Oil and Gas
µPa	Micro-Pascal – reference unit for sound pressure
WHO	World Health Organisation

2 Acoustic Concepts and Terminology

- 2.1 This section provides an overview of the fundamentals of how sound propagates away from a source.
- 2.2 Increasing the distance from a noise source normally results in the level of noise getting quieter, due primarily to the spreading of the sound with distance, analogous to the way in which the ripples in a pond spread after a stone has been thrown in. Another important factor relates to the type of ground over which the sound is travelling. Acoustically “soft” ground, (such as grassland, ploughed fields etc.) will result in lower levels of noise with increasing distance from the noise source as compared to acoustically “hard” surfaces (e.g. concrete, water, paved areas). The reduction in noise level depends, however, on the frequency of the sound.
- 2.3 Wind also affects the way in which sound propagates, with noise levels downwind of a source being louder than upwind. This is partly due to the sound ‘rays’ being bent either upwards or downwards by the wind in a similar way that light is bent by a lens, as shown in Figure 2.1. Varying temperatures in the atmosphere can also cause sound ‘rays’ to be bent, adding to the complexity of sound propagation.

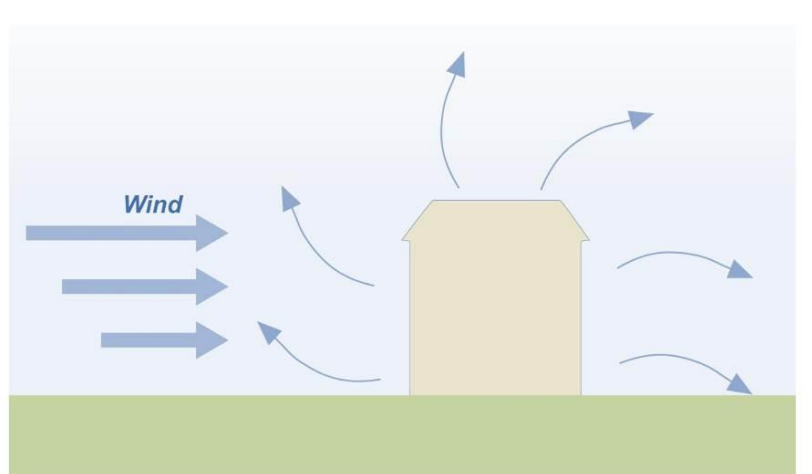

Figure 2.1 Refraction of sound waves due to wind gradients (increasing wind speed with height)

- 2.4 Another attenuation mechanism is absorption of sound by the molecules of the atmosphere. Higher pitched (higher frequency) sounds are more readily absorbed than lower pitched (lower frequency) sounds. The factors affecting the extent to which the sound is absorbed are the temperature and the water content of the atmosphere (relative humidity).
- 2.5 The effect of varying temperature and humidity is usually minimal when compared to other factors, such as wind and ground effects. However, where high frequency sounds are encountered, there may well be a significant variation between measured sound levels on different days due to variations in temperature and humidity.
- 2.6 When hearing noise which occurs out in the open (e.g. from road traffic, aircraft, birds, wind in the trees etc.), it is common experience that the noise level is not constant in loudness but is changing

in amplitude all of the time. Therefore, in order to numerically describe the noise levels, it is beneficial to use statistical parameters. It has become practice to use indices which describe the noise level which has been exceeded for a certain percentage of the measurement period, and also an index which gives a form of average of the sound energy over a particular time interval. The former are termed percentile noise levels and are notated L_{A90} , L_{A50} , L_{A10} etc. and the latter is termed the equivalent continuous noise level and is notated by L_{Aeq} . It is worth noting that if the noise level does not vary with time, then all the parameters, in theory, normalise to a single value.

- 2.7 With regard to the percentile levels, the L_{A90} is the sound pressure level which is exceeded for 90% of the measurement time. It is generally used as the measure of background noise (i.e. the underlying noise) in environmental noise standards.
- 2.8 The L_{Aeq} (sometimes denoted $L_{Aeq,T}$) is the A-weighted equivalent continuous noise level and is an energy averaged value of the actual time varying sound pressure level over the time interval, T. It is used in the UK as a measure of the noise level of a specific industrial noise source when assessing the level of the specific source against the background noise. It is also used as a measure of ambient noise (i.e. the “all-encompassing” sound field).
- 2.9 Other useful parameters for describing noise include the maximum and minimum sound pressure level encountered over the time period, denote L_{Amax} and L_{Amin} respectively.
- 2.10 The term 'A' weighting implies a measurement made using a filter with a standardised frequency response which approximates the frequency response of the human ear at relatively low levels of noise. The resulting level, expressed in 'A' weighted decibels, or dBA, is widely used in noise standards, regulations and criteria throughout the world.
- 2.11 For a more detailed analysis of the frequency characteristics of a noise source, then noise measurements can be made in bands of frequencies, usually one octave wide. The resulting levels are termed octave band sound pressure levels. The standard octave band centre frequencies range from 31.5 Hz (about three octaves below middle 'C' on the piano) to 8 kHz (about five octaves above middle 'C'). This covers most of the audible range of frequencies (usually taken to be around 20 Hz to 20 kHz). Octave band noise levels are usually quoted as linear data – i.e. without an 'A' weighting filter being applied. For more detailed analysis narrowband filters are useful for analysing tones.
- 2.12 The term decibel is a relative quantity and should always be referenced to an absolute level. In this report, all sound pressure levels (denoted L_p) are expressed in dB re 20 μ Pa. Hence, a sound pressure level of 0 dBA refers to a pressure level of 20 μ Pa, which is generally taken as the lowest level of sound that the human ear can detect. A negative dBA value usually implies that the sound is below the threshold of human hearing.
- 2.13 Subjectively, and for steady noise levels, a change in noise level of 3 dB is normally just discernible to the human ear. However, a noise change of less than 3 dB could be discernible if it has particular frequency characteristics or if it varies in loudness over time. A difference of 10 dB represents a doubling or halving of subjective loudness.

- 2.14 Sound power (denoted L_W) is the acoustical power radiated from a sound source. The advantage of using the sound power level, rather than the sound pressure level, in reporting noise from a source is that the sound power is independent of the location of the source, distance from the measurement point and environmental conditions. If the sound power of a source is known, then it is possible to calculate the sound pressure level at a distance away from the source, accounting for the attenuation due to propagation, as discussed above.
- 2.15 A useful analogy can be made to a radiator in a room. Sound power is analogous to the power rating of the radiator, whereas sound pressure is analogous to the resulting temperature.
- 2.16 Sound power levels are referenced to power rather than pressure; hence sound power levels are expressed in dB re 1 pW.

3 Summary of Relevant Policy, Guidance and Standards

Noise Policy Statement for England

- 3.1 The Noise Policy Statement for England (NPSE) [1] sets out the long term overarching vision of Government noise policy, which is to promote good health and a good quality of life through the management of noise within the context of Government policy on sustainable development. Whilst the NPSE does not seek to change pre-existing policy, the document is intended to aid decision makers by making explicit the implicit underlying principles and aims regarding noise management and control that are to be found in existing policy documents, legislation and guidance.
- 3.2 The NPSE describes a Noise Policy Vision and three Noise Policy Aims and states that these vision and aims provide “the necessary clarity and direction to enable decisions to be made regarding what is an acceptable noise burden to place on society.”
- 3.3 In other words, the purpose of the NPSE is to provide guidance for the decision maker on whether or not the noise impact is an acceptable burden to bear in order to receive the economic and other benefits of the proposal.
- 3.4 Where existing policy and guidance does not provide adequate guidance then decision makers can go back to the aims of the policy statement to provide overriding guidance. The “Noise Policy Vision” is to “promote good health and good quality of life through the effective management of noise within the context of Government policy on sustainable development”. This long term vision is supported by the following aims, through effective management and control of environmental, neighbour and neighbourhood noise within the context of Government policy on sustainable development:
- i. avoid significant adverse impacts of health and quality of life;
 - ii. mitigate and minimise adverse impacts on health and quality of life; and
 - iii. where possible, contribute to the improvement of health and quality of life.
- 3.5 The aims of the policy differentiate between noise impacts on health (e.g. sleep disturbance, hypertension, stress etc.) and noise impacts on quality of life (e.g. amenity, enjoyment of property etc.). The aims also differentiate between “significant adverse impacts” and “adverse impacts”. The explanatory note to the NPSE clarifies that a significant adverse impact is deemed to have occurred if the “Significant Observed Adverse Effect Level” (SOAEL) is exceeded. An adverse effect, on the other hand, lies between the “Lowest Observed Adverse Effect Level” (LOAEL) and the SOAEL.
- 3.6 In assessing whether a development should be permitted, there are therefore four questions that should be answered, with reference to the principles of sustainable development, viz. will the development result in:
- a) a significant adverse impact to health;
 - b) a significant adverse impact to quality of life;

- c) an adverse impact to health; or
 - d) an adverse impact to quality of life?
- 3.7 If the answer to question a) or b) is yes, then the NPSE provides a clear guidance that the development should be viewed as being unacceptable (item i. above). If the answer to question c) or d) is yes, then the NPSE provides a clear steer that the impact should be mitigated and minimised (item ii. above).

National Planning Policy Framework

- 3.8 The National Planning Policy Framework (NPPF) [2] sets out the Government's planning policies for England and how these are expected to be applied. The emphasis of the Framework is to allow development to proceed where it can be demonstrated to be sustainable. In relation to noise, Paragraph 180 of the Framework states:

“Planning policies and decisions should ensure that new development is appropriate for its location taking into account the likely effects (including cumulative effects) of pollution on health, living conditions and the natural environment, as well as the potential sensitivity of the site or the wider area to impacts that could arise from the development. In doing so they should:

- a) mitigate and reduce to a minimum potential adverse impacts resulting from noise from the development – and avoid noise giving rise to significant adverse impacts on health and the quality of life;*
- b) identify and protect tranquil areas which have remained relatively undisturbed by noise and are prized for their recreational and amenity value for this reason; and*
- c) limit the impact of light pollution from artificial light on local amenity, intrinsically dark landscapes and nature conservation.”*

- 3.9 Point 'a)' refers to 'significant adverse impacts' which relates to the 'significant observed adverse effect level' (SOAEL) in the Noise Policy Statement for England (NPSE), though the term 'effect' is used instead of 'impact' these are interchangeable in this context.

- 3.10 Paragraph 203 of the Framework notes that *“It is essential that there is a sufficient supply of minerals to provide the infrastructure, buildings, energy and goods that the country needs. Since minerals are a finite natural resource, and can only be worked where they are found, best use needs to be made of them to secure their long-term conservation.”* Paragraph 204 goes on to state that *“Planning policies should:... g) when developing noise limits, recognise that some noisy short-term activities, which may otherwise be regarded as unacceptable, are unavoidable to facilitate minerals extraction...”*

- 3.11 The NPPF therefore explicitly recognises that it may be necessary to allow noise levels due to minerals extraction to give rise to higher short term impacts than would otherwise be acceptable for other types of industry. Further explanation and guidance on this is provided in the Planning Practice Guidance on Minerals (see below).

Planning Practice Guidance - Noise

- 3.12 Planning Practice Guidance on Noise (PPG-N) [3] provides guidance to local planning authorities to ensure effective implementation of the planning policy set out in the National Planning Policy Framework. The PPG suggests that planning authorities should ensure that unavoidable noise emissions are controlled, mitigated or removed at source and establish appropriate noise limits for extraction in proximity to noise sensitive properties.
- 3.13 The PPG-N reiterates general guidance on noise policy and assessment methods provided in the NPPF, NPSE and British Standards and contains examples of acoustic environments commensurate with various effect levels. Paragraph 006 of the PPG-N explains that:
- 3.14 “The subjective nature of noise means that there is not a simple relationship between noise levels and the impact on those affected. This will depend on how various factors combine in any particular situation.”
- 3.15 According to the PPG-N, factors that can influence whether noise could be of concern include:
- the source and absolute level of the noise together with the time of day it occurs;
 - for non-continuous sources of noise, the number of noise events, and the frequency and pattern of occurrence of the noise;
 - the spectral content and the general character of the noise;
 - the local topology and topography along with the existing and, where appropriate, the planned character of the area;
 - where applicable, the cumulative impacts of more than one source should be taken into account along with the extent to which the source of noise is intermittent and of limited duration;
 - whether adverse internal effects can be completely removed by closing windows and, in the case of new residential development, if the proposed mitigation relies on windows being kept closed most of the time;
 - in cases where existing noise sensitive locations already experience high noise levels, a development that is expected to cause even a small increase in the overall noise level may result in a significant adverse effect occurring even though little to no change in behaviour would be likely to occur;
 - where relevant, Noise Action Plans, and, in particular the Important Areas identified through the process associated with the Environmental Noise Directive and corresponding regulations;
 - the effect of noise on wildlife;
 - if external amenity spaces are an intrinsic part of the overall design, the acoustic environment of those spaces; and

- the potential effect of a new residential development being located close to an existing business that gives rise to noise should be carefully considered. This is because existing noise levels from the business even if intermittent (for example, a live music venue) may be regarded as unacceptable by the new residents and subject to enforcement action. To help avoid such instances, appropriate mitigation should be considered, including optimising the sound insulation provided by the new development’s building envelope. In the case of an established business, the policy set out in the third bullet of paragraph 123 of the NPPF should be followed.

3.16 The PPG-N provides a relationship between various perceptions of noise, effect level and required action in accordance with the NPPF. This is reproduced in Table 3.1, below.

Table 3.1: Noise Exposure Hierarchy Based On the Likely Average Response

Perception	Examples of Outcomes	Increasing Effect Level	Action
Not noticeable	No Effect	No Observed Effect	No specific measures required
Noticeable and not intrusive	Noise can be heard, but does not cause any change in behaviour or attitude. Can slightly affect the acoustic character of the area but not such that there is a perceived change in the quality of life.	No Observed Adverse Effect	No specific measures required
		Lowest Observed Adverse Effect Level	
Noticeable and intrusive	Noise can be heard and causes small changes in behaviour and/or attitude, e.g. turning up volume of television; speaking more loudly; where there is no alternative ventilation, having to close windows for some of the time because of the noise. Potential for some reported sleep disturbance. Affects the acoustic character of the area such that there is a perceived change in the quality of life.	Observed Adverse Effect	Mitigate and reduce to a minimum
		Significant Observed Adverse Effect Level	
Noticeable and disruptive	The noise causes a material change in behaviour and/or attitude, e.g. avoiding certain activities during periods of intrusion; where there is no alternative ventilation, having to keep windows closed most of the time because of the noise. Potential for sleep disturbance resulting in difficulty in getting to sleep, premature awakening and difficulty in getting back to sleep. Quality of life diminished due to change in acoustic character of the area.	Significant Observed Adverse Effect	Avoid
Noticeable and very disruptive	Extensive and regular changes in behaviour and/or an inability to mitigate effect of noise leading to psychological stress or physiological effects, e.g. regular sleep deprivation/awakening;	Unacceptable Adverse Effect	Prevent

Perception	Examples of Outcomes	Increasing Effect Level	Action
	loss of appetite, significant, medically definable harm, e.g. auditory and non-auditory.		

- 3.17 The PPG-N describes sound that is not noticeable to be at levels below the No Observed Effect Level (NOEL). It describes exposures that are noticeable but not to the extent there is a perceived change in quality of life as below the LOAEL and need no mitigation. The audibility of sound from a development is not, in itself, a criterion to judge noise effects that is commensurate with national planning policy.
- 3.18 The PPG-N suggests that noise exposures above the LOAEL cause small changes in behaviour. Examples of noise exposures above the LOAEL provided in the PPG-N include:
- having to turn up the volume on the television;
 - needing to speak more loudly to be heard;
 - where there is no alternative ventilation, closing windows for some of the time because of the noise; or
 - a potential for some reported sleep disturbance.
- 3.19 In line with the NPPF and NPSE, the PPG-N states that consideration needs to be given to mitigating and minimising effects above the LOAEL but taking account of the economic and social benefits being derived from the activity causing the noise.
- 3.20 The PPG-N suggests that noise exposures above the SOAEL cause material changes in behaviour. Examples of noise exposures above the SOAEL provided in the PPG-N are:
- where there is no alternative ventilation, keeping windows closed for most of the time or avoiding certain activities during periods when the noise is present; and/or
 - there is a potential for sleep disturbance resulting in difficulty in getting to sleep, premature awakening and difficulty in getting back to sleep.
- 3.21 In line with the NPPF and NPSE, the PPG-N states that effects above the SOAEL should be avoided and that, whilst the economic and social benefits being derived from the activity causing the noise must be taken into account, such exposures are undesirable.
- 3.22 The PPG-N suggests that a noise impact may be partially offset if the residents of affected dwellings have access to a relatively quiet part of their dwelling, private external amenity area and/or external public or private amenity space nearby.

Planning Practice Guidance on Minerals (PPG-M)

- 3.23 The PPG-M [4] provides guidance to mineral planning authorities to ensure effective implementation of the planning policy set out in the NPPF. The PPG-M adopted the criteria from the Technical Guidance which initially accompanied the NPPF (and was withdrawn on 7th March

2014) and this adopted the criteria previously set out in the replaced Minerals Policy Statement (MPS) 2, Annex 2 and the earlier Minerals Planning Guidance (MPG) 11.

3.24 The PPG-M suggests that minerals planning authorities should ensure that unavoidable noise emissions are controlled, mitigated or removed at source and appropriate noise limits established for extraction in proximity to noise sensitive properties.

3.25 The PPG-M also suggests that development proposals should include a noise emissions assessment, to include identification of all sources of noise and, for each source, consider the proposed operating locations, procedures, schedules and duration of work for the life of the operation. The proposals for the control or mitigation of noise emissions should consider:

- the main characteristics of the production process and its environs, including the location of noise-sensitive properties;
- proposals to minimise, mitigate or remove noise emissions at source;
- assessing the existing noise climate around the site of the proposed operations, including background noise levels at nearby noise-sensitive properties;
- estimating the likely future noise from the development and its impact on the neighbourhood of the proposed operations;
- monitoring noise emissions to ensure compliance with appropriate environmental standards.

3.26 The guidance goes on to state that planning authorities will need to consider whether the overall effect of the noise exposure would be above or below the SOAEL and LOAEL, and whether a good standard of amenity can be achieved taking account of the prevailing acoustic environment.

3.27 The PPG-M sets out noise level criteria to be achieved by mineral extraction operations:

“Mineral planning authorities should aim to establish a noise limit, through a planning condition, at the noise-sensitive property that does not exceed the background noise level ($L_{A90,1h}$) by more than 10 dBA during normal working hours (0700 – 1900). Where it will be difficult not to exceed the background level by more than 10 dBA without imposing unreasonable burdens on the mineral operator, the limit set should be as near that level as practicable. In any event, the total noise from the operations should not exceed 55 dB $L_{Aeq,1h}$ (free field). For operations during the evening (1900-2200) the noise limits should not exceed the background noise level ($L_{A90,1h}$) by more than 10 dBA and should not exceed 55 dB $L_{Aeq,1h}$ (free field). For any operations during the period 22.00 – 07.00 noise limits should be set to reduce to a minimum any adverse impacts, without imposing unreasonable burdens on the mineral operator. In any event the noise limit should not exceed 42 dB $L_{Aeq,1h}$ (free field) at a noise sensitive property.

Where the site noise has a significant tonal element, it may be appropriate to set specific limits to control this aspect. Peak or impulsive noise, which may include some reversing beepers, may also require separate limits that are independent of background noise (e.g. L_{max} in specific octave or third-octave frequency bands – and that should not be allowed to occur regularly at night.)

Care should be taken, however, to avoid any of these suggested values being implemented as fixed thresholds as specific circumstances may justify some small variation being allowed.

- 3.28 All mineral operations will have some particularly noisy short-term activities that cannot meet the limits set for normal operations. Examples include soil-stripping, the construction and removal of baffle mounds, soil storage mounds and spoil heaps, construction of new permanent landforms and aspects of site road construction and maintenance. However, these activities can bring longer-term environmental benefits. In relation to this, the PPG-M states:

“Increased temporary daytime noise limits of up to 70 dBA $L_{Aeq,1h}$ (free field) for periods of up to eight weeks in a year at specified noise-sensitive properties should be considered to facilitate essential site preparation and restoration work and construction of baffle mounds where it is clear that this will bring longer-term environmental benefits to the site or its environs.

Where work is likely to take longer than eight weeks, a lower limit over a longer period should be considered. In some wholly exceptional cases, where there is no viable alternative, a higher limit for a very limited period may be appropriate in order to attain the environmental benefits. Within this framework, the 70 dBA $L_{Aeq,1h}$ (free field) limit referred to above should be regarded as the normal maximum.”

- 3.29 The noise limits in the guidance for minerals extraction sites is higher than would normally be tolerated for permanent industrial development of the same scale for two reasons, namely:
- the options for the location of minerals extraction sites is limited by the location of the natural resource; and
 - minerals extraction activities are usually limited in duration due to the resources eventually running out.

- 3.30 It is relevant to note that the PPG-M specifically recognises that minerals extraction sites are limited in where they can be situated due to the location of the natural resource. In this respect, the PPG-M does not include any recommendations for establishing a buffer zone around a site, instead taking the approach of setting suggested noise thresholds.

- 3.31 The PPG-M was published after publication of, and takes into account the recommendations of, the World Health Organisation guidelines as described in the following section.

World Health Organisation (WHO) Guidelines

- 3.32 In 2009 a report was published presenting the conclusions of a World Health Organisation (WHO) working group responsible for preparing guidelines for exposure to noise during sleep entitled “Night Noise Guidelines for Europe” [5] (NNG). The document can be seen as an extension to the original 1999 WHO Guidelines for Community Noise. Various effects are described including biological effects, sleep quality, and well-being. The document gives threshold levels for observed effects expressed as $L_{max, inside}$ and $L_{night, outside}$.

- 3.33 The L_{night} is a *year-long average* night-time noise level, not taking into account the façade effect of a building. In an exposed population a noise exposure of 40 dB $L_{\text{night, outside}}$ is stated as equivalent to the “lowest observed adverse effect level” for night noise. Above this level adverse health effects observed are self-reported sleep disturbance, environmental insomnia and increased use of somnifacient drugs and sedatives. Above 55 dB $L_{\text{night, outside}}$ cardiovascular effects become the major public health concern. Threshold levels for waking in the night, and/or too early in the morning are given as 42 dB $L_{\text{Amax, inside}}$. Lower thresholds are given that may change sleep structure.
- 3.34 The effects of different levels of night noise on the population’s health in the NNGs are summarised in Table 3.2.

Table 3.2: Summary of Observed Health Effects in the Population (WHO NNG)

Noise Level, $L_{\text{night, outside}}$	Observed Effect
up to 30 dBA	No substantial biological effects are observed.
30 to 40 dBA	A number of effects are observed to increase: body movements, awakening, self-reported sleep disturbance, arousals. The intensity of the effect depends on the nature of the source and on the number of events, even in the worst cases the effects seem modest.
40 to 55 dBA	Adverse health effects are observed along the exposed population. Many people have to adapt their lives to cope with the noise at night. Vulnerable groups are now severely affected.
Above 55 dBA	The situation is considered increasingly dangerous for public health. Adverse health effects occur frequently, a high percentage of the population is highly annoyed and there is limited evidence that the cardiovascular system is coming under stress.

- 3.35 As mentioned previously, the $L_{\text{night, outside}}$ parameter is an annual average noise level excluding the effect of the façade. It is relevant to note that typical night to night variation in noise levels that occur due to meteorological effects and the effects of a façade, the NNG value of 40 dB $L_{\text{night, outside}}$ is equivalent to the threshold for sleep disturbance previously given in the 1999 WHO report [6] (an external façade noise level of 45 dB L_{Aeq}), although expressed in a different way. Similarly, taking into account variations in noise level from night to night over the course of a year, the 40 dB $L_{\text{night, outside}}$ threshold is also equivalent to the 42 dB $L_{\text{Aeq,1h}}$ threshold defined in the PPG-M. The short measurement time (1 hour) of the PPG-M limit means that the 42 dB $L_{\text{Aeq,1h}}$ threshold would need to be met at all times, including when the receptor is downwind from the site or under a moderate temperature inversion. During periods when the receptor is upwind from the site, noise levels will typically be 5 to 10 dB lower. Averaging these variations in meteorological effects over a period of a year, or 3 months in the case of a typical drilling programme, the annual average noise level would be approximately 2 to 3 dB lower than the noise level under conditions favourable to sound propagation. Consequently, it can be concluded that the PPG-M noise thresholds are entirely consistent with the recommendations of the WHO NNG.
- 3.36 The use of yearly average parameters in the WHO guidance is a fundamental aspect of the NNG. The thresholds are based on potential health effects at population level due to long-term exposure

to noise. It follows that it is unlikely that exposure to higher levels of noise over a shorter period of time would result in the same health impacts. Consequently, it can also be concluded that the PPG-M's provision for higher noise thresholds for short term activities is also consistent with the recommendations of the WHO guidelines.

- 3.37 The WHO guideline values give the lowest threshold noise levels below which the occurrence rates of particular effects can be assumed to be negligible. Exceedances of the WHO guideline values do not necessarily imply significant noise impact and, indeed, it may be that significant impacts do not occur until much higher degrees of noise exposure are reached.
- 3.38 Guidance on desirable levels of environmental noise is also given in the 1999 report. Section 4.3.1 of the document states that *"to protect the majority of people from being seriously annoyed during the daytime, the sound pressure level on balconies, terraces and outdoor living areas should not exceed 55 dB L_{Aeq} for a steady continuous noise. To protect the majority of people from being moderately annoyed during the daytime, the sound pressure level should not exceed 50 dB L_{Aeq}. These values are based on annoyance studies but most countries in Europe have adopted 40 dB L_{Aeq} as the maximum allowable level for new developments."*
- 3.39 The daytime value of 40 dB L_{Aeq} for new developments is very low and, in my experience, is not consistent with the criteria adopted for new developments (be it new noise sensitive development or new noise sources) in the UK. The values for moderate and serious annoyance are, however, consistent with UK planning policy.
- 3.40 The WHO guidelines have not been formally adopted into UK legislation or guidance, hence it remains a source of information reflecting a high level of health care with respect to noise, rather than a standard to be rigidly applied. The guideline values give the lowest threshold noise levels below which the occurrence rates of particular effects can be assumed to be negligible. Exceedances of the WHO guideline values do not necessarily imply significant noise impact and indeed, it may be that significant impacts do not occur until much higher degrees of noise exposure are reached.
- 3.41 The major concern in Europe is with respect to noise from transportation systems, and most of the studies on which these guidelines are based relate to this type of noise source. There can be no certainty that the same effects will be observed from noise of an industrial nature, but in the absence of any more detailed information some weight should be attached to the WHO guidance when assessing industrial noise as well.
- 3.42 In 2001 the Defra-funded National Noise Incidence Survey [7] measured external noise levels outside 1,160 dwellings throughout the UK over 24-hour periods spread over the course of the year. The study concluded that an estimated 55% of the population of the United Kingdom live in dwellings exceeding the recommended WHO daytime noise level threshold of 55 dB L_{Aeq} and that 67% live in dwellings exceeding the night-time threshold for sleep disturbance of 45 dB L_{Aeq}.

- 3.43 It is concluded that the thresholds set out in the PPG-M accord with the WHO guidelines summarised above. Both the daytime and night time noise thresholds in the PPG-M are consistent with the WHO guideline limits for avoidance of sleep disturbance and onset of annoyance.
- 3.44 New guidance was issued by the WHO in 2018 [8]. The guidelines are intended to provide recommendations for protecting human health from exposure to environmental noise originating from various sources: transportation noise (road traffic, railway and aircraft), wind turbine noise and leisure noise. The guidelines do not consider industrial noise, mainly due to the large heterogeneity and specific features of industrial noise, and the fact that exposure to industrial noise has a very localized character in the urban population. Consequently, with the possible exception of road traffic noise, the new guidelines are not of relevance to oil and gas development. With respect to road traffic noise, the guidelines recommend a threshold of 53 dB L_{den} (i.e. the day-evening-night-weighted sound pressure level) and 45 dB L_{night} .

British Standard 4142

- 3.45 British Standard 4142:2014 [9] describes a method for rating and assessing sound of an industrial and/or commercial nature. The standard is applicable to the determination of the rating level of industrial or commercial sound as well as the ambient, background and residual noise levels for the purposes of investigating complaints, assessing sound from proposed new, modified or additional sources or assessing sound at proposed new dwellings. The determination of whether a noise amounts to a nuisance is beyond the scope of the standard, as is rating and assessment of indoor noise levels.
- 3.46 The standard compares the “rating level” of the noise (i.e. the specific noise level from the site under investigation adjusted using penalties for acoustic character such as tonality or impulsiveness) with the pre-existing background noise level.
- 3.47 Paragraph 1.3 of BS 4142 states that “the standard is not intended to be applied to the rating and assessment of sound from other sources falling within the scopes of other standards or guidance”. In this respect, BS 4142 is not applicable to noise from mineral operations, including oil and gas exploration and appraisal, because these activities fall within the scope of other guidance; specifically the PPG-M.

Consideration of Relevant Appeal Decisions

- 3.48 I have reviewed a number of relevant appeal decisions in relation to onshore oil and gas exploration in order to see how noise was addressed and which standards, guidance and criteria have been applied. These are summarised as follows:

Cuadrilla Preston New Road and Rosacre Wood

- 3.49 The Inspector’s report [10] determined that the PPG-M was the relevant standard to be applied and that:

- i. the use of BS 4142 is not applicable for assessing the noise impact from oil and gas exploration (paras 12.219, 12.522); and
- ii. BS 5228 does not provide relevant specific guidance for determining appropriate maximum noise levels for oil and gas exploration sites (paragraph 12.212).

3.50 The Inspector considered that it is relevant to have regard to a comparison of the levels likely to be produced by the development with the baseline ambient noise levels, concluding that this would be consistent with a sensible and reasonable reading of PPG-M (para 12.522).

3.51 For Preston New Road, the noise limits are 39 dBA for night-time and 55 dBA for the daytime.

Ineos Harthill

3.52 The Inspector's report [11] concluded that the PPG-M criteria of 55 dBA during the daytime and 42 dBA at night were the appropriate thresholds against which to assess noise (paras 98 – 100).

Ineos Bramley Moor Lane

3.53 The Inspector's report [12] concluded that the length of the proposed activities (3 months) meant that a higher noise limit could be used compared to the Preston New Road site (para 28).

3.54 The Inspector concluded that BS 4142 was not the appropriate standard to assess noise from the development against and that PPG-M should be used (para 30).

3.55 Despite noise levels being contrary to policy MP1(1) of the Derby and Derbyshire Minerals Local Plan, the Inspector concluded that it would be possible to control overall noise levels to those set in the PPG-M and the WHO guidelines, to which she gave significant weight (para 36).

3.56 The noise limits for the site were set at 47 dBA during the daytime, 43 dBA in the evening and 42 dBA at night.

Lodge Farm

3.57 Noise was not a significant issue for this appeal and the Inspector's report [13] concluded that conditions could be imposed controlling daytime and night time noise to acceptable levels (para 33). In this respect, it is notable that the planning conditions were 55 dB L_{Aeq} during the daytime and 42 dB L_{Aeq} at night, i.e. based on the PPG-M thresholds. Separate conditions were also imposed to limit maximum noise events (based on the L_{Amax} parameter).

Conclusions

3.58 Based on my review of relevant appeal decisions in relation to onshore oil and gas exploration, I have concluded that:

- PPG-M has been determined to be the applicable standard for setting noise thresholds in all of the cases reviewed;
- Neither BS 4142 or BS 5228 are applicable to assessing noise from oil and gas exploration and appraisal activities;

- The duration of the activities and the baseline ambient sound are both factors which have a bearing on the acceptable noise level due to a development.

Summary of Policy, Standards and Guidance to be Applied to Assessing Noise Impact due to the Oil and Gas Development

3.59 Based on my review of policy, guidance and standards my suggested criteria for assessing the effects of noise from the appeal proposals are set out below:

National Planning Policy

3.60 The development should be assessed in accordance with the following national policies:

- National Planning Policy Framework;
- Noise Policy Statement for England;
- Planning Practice Guidance - Noise; and
- Planning Practice Guidance - Minerals.

3.61 Of these, the critical and pre-eminent guidance is the PPG-M which deals with the issue of noise from oil and gas extraction sites in detail.

Other Guidance and Standards

3.62 Consideration should also be given to the following guidance:

- WHO Night Noise Guidelines (note - it has been established that the PPG-M noise thresholds are consistent with the thresholds recommended in WHO Guidelines).

3.63 It may be relevant to refer to other standards and guidance on a site specific basis for activities that fall outside the definition of oil and gas exploration and appraisal. For example, reference could be made to BS 5228 for wellsite construction noise.

4 Typical Sound Power Levels for Different Phases of Onshore Oil and Gas Development

Construction and Traffic

- 4.1 Noise due to the construction of oil and gas development sites is similar to construction of other types of development, including industrial, residential, commercial and infrastructure development. The methodologies and equipment used in the construction activities do not differ significantly from construction activities in these other industries. In this respect, noise issues for the construction phase of oil and gas developments can be treated in a similar way, using similar assessment techniques, to other industries.
- 4.2 Likewise, traffic movements associated with oil and gas development do not differ significantly from other industries in terms of the types of vehicles used. Traffic noise can therefore be assessed using the same methodologies as used in other industries. It is worth noting that the vast majority of oil and gas developments limit HGV movements to within the daytime period.

Drilling

- 4.3 By necessity, drilling and associated operations occur on a 24 hour basis and, as such, it is the night-time situation rather than the daytime which is generally more critical.
- 4.4 Usually, at the planning stage of the development, it is not possible to make a decision on the exact rig to be utilised. The choice of rig will depend on several factors, including rig availability at the time the wells are to be drilled and rig suitability. Consequently, it is common practice to examine the noise characteristics from one or more typical “worst case” types of rig during the planning phase in order to determine the suitability of the site and area with regard to potential noise impacts and the types of mitigation required.
- 4.5 In order to provide a range of potential impacts to the Inspector, the sound power level data pertaining to a number of typical drilling rigs used in the UK and Europe is presented in Table 4.1. The rigs included in this report are typical of the types of rig that are used during drilling and workover stages. Different rigs produce different noise levels and noise characteristics and the rigs selected are considered to give a representative range of the noise levels and characters that could occur from any selected rig. It is expected that other rigs of a comparable type will have a similar noise footprint.
- 4.6 It is apparent that the mitigation measures installed on each rig can vary depending on the site and area in question and the operating scenario. For example, some rigs include enclosed mud pumps when operating at noise sensitive sites but the enclosures are not needed at less sensitive locations. This allows flexibility in approach to be adopted depending on the site specific circumstances. This adaptable approach is sensible because it follows Best Practicable Means (BPM) principles and balances the various negative factors due to installing mitigation (e.g.

increased risk of gas entrapment, reduced escape routes, reduced visibility, more difficult maintenance, additional cost) against the benefits of noise reduction where needed. Furthermore, the equipment required for each well may differ for any given rig depending on the operational scenario and site specific requirements.

- 4.7 This flexible approach also enables different noise mitigation measures to be assessed as part of an environmental noise assessment. Usually, the requirements for acoustic mitigation are determined by a combination of factors such as the baseline noise environment, distance to the nearest noise sensitive receptors and the extent of local screening etc. A range of possible and alternative mitigation approaches is usually assessed for each candidate rig and a BPM assessment performed depending on the site specific circumstances. Consequently, the equipment used and sound power levels presented for the various rigs is likely to differ between sites. In this respect, it is important to note that noise limits will usually be imposed by the Mineral Planning Authority as part of the planning conditions attached to any Planning Permission. It is the responsibility of the developer to use plant and machinery and employ mitigation measures necessary to comply with the imposed limits, and to demonstrate compliance by means of monitoring.

Table 4.1: Sound power level data for drilling rigs, dBA re 1 pW

Rig / equipment item	Overall L _w , dBA
Boldon Rig 92	
<i>Top drive- without enclosure</i>	99
<i>Top drive- with enclosure</i>	95
Top drive blower	96
Mud pump enclosure	102
Generator including exhaust (per generator)	100
Marriott HH-220	
Generator enclosure (per generator)	95
Generator exhaust (per generator)	100
Top Drive (80-90 rpm) (enclosed)	92
<i>Mud pump (per pump, unenclosed)</i>	104
<i>Mud pumps enclosure (2 of 3 pumps operating) - Enclosed</i>	98
Shale shakers (enclosed)	84
Sand screen (enclosed)	81
Hydraulic Power Unit (enclosed)	89
Centrifuge (enclosed)	89
DrillTec VDD 370	
Generator enclosure (per generator)	98
Generator Exhaust (per generator)	96
Mud Pump Drive Motor (per pump)	100
Mud Pump (per pump)	90

Rig / equipment item	Overall L _w , dBA
Main HPU	97
Auxiliary HPU	95
Shale Shakers	102
Agitators	96
Centrifuge (Enclosed)	92
Top Drive (Enclosed)	93
Bentec T-49	
Generator enclosure (per generator)	102
Generator exhaust (per generator)	91
Mud pumps	107
Shale shakers	104
Top drive	101
Pipe handler	94
Centrifuge	96
Bentec T-208	
Mud pump motor (per pump)	103
Mud pump (per pump)	95
Shale shaker with enclosure	94
Pumps, agitators and tanks	93
Centrifuge unit	97
Power control unit	94
Top drive (65 rpm)	100
Top drive (130 rpm)	103

Well Workovers

- 4.8 Although the rigs described above can be used for workover operations, typically a workover rig would utilise less equipment with a lower noise footprint than a full rotary equipped rig as used in the drilling phase. For example, mud pumps are not always required or required at a lower capacity. Likewise, the rig is often able to operate with fewer generators running.
- 4.9 Consequently, the noise levels predicted for the rigs assessed would be lower during well workover than during the “full” drilling phase, although the sources of noise are similar in nature.
- 4.10 An example a rig often used for well workover is the BDF Drilling Rig 29 which consists of a lorry mounted drilling platform and draw-works, together with other mobile equipment (when required) such as diesel driven mud pumps, shale shakers and generators. Sound power levels under a range of operating scenarios are summarised in Table 4.2.

Table 4.2: Sound power level data for workover / well intervention, dBA re 1 pW

Rig / equipment item	Overall L _w , dBA
BDF Rig 29	
Workover rig total sound power – no rotary capability	100
Workover rig total sound power – partial rotary capability	105
Workover rig total sound power – full rotary capability	109

Hydraulic Fracture Stimulation

- 4.11 Depending on the sensitivity to noise, it is often possible to undertake hydraulic fracturing operations during the daytime only. Planning conditions usually specify hours of working and often prohibit hydraulic fracturing pumps from operating in the evening, night time, Saturday afternoons, Sundays and bank holidays.
- 4.12 There are a limited number of operating frac spreads operating in the UK and Europe and, in some cases, the only data available are measured off-load or in the yard. Off-load data can be unrepresentative of operations at full load because the sound power level increases significantly once the pumps are on load (typically by 15 dB or more).
- 4.13 The type of equipment and number of pumps will be site specific and therefore it is difficult to determine a “typical” operation. However, in general, a frac spread will comprise a sand move, blender and a number of frac pumps. The number of frac pumps used is dependent on operational parameters and can vary between sites. The equipment currently used in the UK is typically diesel powered and the industry is actively working with manufacturers to determine the feasibility of alternative equipment, including enhanced acoustic treatment of equipment. Consequently, it is likely that the sound power level of equipment will reduce as the UK fracking industry matures.
- 4.14 Sound power level data measured for example frac spreads are summarised in Table 4.3. These vary from small, acoustically enclosed frac spreads to large unenclosed frac spreads (although the latter has not been used in the UK to date).

Table 4.3: Sound power level data for on load fracking equipment, dBA re 1 pW

Site / Equipment item	Overall L _w , dBA
Preston New Road (Schlumberger enclosed pumps)	
Blender	115
Enclosed frac pump (per pump)	115
Gel unit	118
Preese Hall (unenclosed pumps)	
Total for site	122
Wysin, Poland (United Oilfield Services unenclosed frac pumps)	
Sand mover	113
Blender	127
Unenclosed frac pump (per pump)	123

Site / Equipment item	Overall L _w , dBA
Halliburton Frac Pumps	
Unenclosed "Grizzly" frac pump (per pump)	126
Enclosed "Grizzly" frac pump (per pump)	107

- 4.15 The type of equipment and number of pumps used will vary from site to site and will be determined by the operational requirements, baseline noise environment and any planning noise limits. Operators utilise a variety of noise control techniques, including choice of pumps and screening, to mitigate noise levels to as low as possible using BPM. In any case, the choice of equipment and mitigation scheme is ultimately constrained by the planning noise limits which the operators must comply with.
- 4.16 Additional mitigation, in the form of acoustic barriers, is often used to reduce the impact of hydraulic fracturing operations. Usually, the requirements for additional acoustic mitigation are determined by a combination of factors such as the baseline noise environment, distance to the nearest noise sensitive receptors and the extent of local screening etc., based on BPM principals and controlled by condition
- 4.17 Noise from hydraulic fracturing is similar in nature to noise from any process which requires the use of large, mobile diesel powered machinery. As such, the noise control techniques used in other industries are equally applicable to noise from fracking.

Flow Testing and Well Appraisal

- 4.18 Flaring of gas would generally be avoided other than during initial flow testing and emergencies. Wherever possible, gas would be connected into local transmission lines or used to generate electricity where there are grid connections. Nevertheless, many well sites need to perform flow tests for a limited period of time of up to 90 days.
- 4.19 There are three main types of flare system that can be used for gas appraisal operations:
- **Unenclosed Flares (e.g. elevated pipe flares)** – These flares are usually capable of operating over a very wide range of flowrates and pressures. However, they do not incorporate built in screening of the flare and therefore produce the highest noise levels of the three main flare categories. Consequently, these types of flares are not usually suitable for use in close proximity to residential areas.
 - **Shrouded Ground Flares** - Shrouded ground flares typically incorporate an open pipe flare capable of operating over a wide range of flowrates and pressures. They incorporate a shroud around the flare tip which reduces the environmental noise emissions from the flare. As such, although they are not as quiet as totally enclosed flares, they provide a balance between safety considerations with respect to unknown and variable operating conditions whilst also reducing the potential noise impact.

- **Enclosed Ground Flares** – These types of flares are totally enclosed and typically incorporate multiple nozzles and burners. Enclosed ground flares therefore produce the lowest noise emissions of the three main flare types. However, they operate over a narrow range of conditions, based on known gas compositions, flow rates and pressures.

4.20 Typical noise data for ground flares used for the well test and appraisal phases is summarised in Table 4.4. It should be noted that the sound power level will vary depending on the flow rate, gas composition and other site specific parameters.

Table 4.4: Sound power levels of flares, dB re 1 pW

Equipment	Overall L _w , dBA
Shrouded ground flare 1.5 mmscfd – measured at San Salvo Wellsite, Italy	117
Shrouded ground flare – 1 mmscfd – measured at Albury Wellsite	113
Enclosed ground flare 1.5 mmscfd	108
GBA enclosed ground flare 6 mmscfd	99
GBA enclosed ground flare 2 mmscfd	93

5 Typical Noise Levels at Noise Sensitive Receptors for Different Phases of Onshore Oil and Gas Exploration and Appraisal

Methodology

- 5.1 The noise emissions from the different phases of development and typical equipment used have been modelled using the CadnaA environmental noise prediction software. This model calculates the contribution from each noise source input as a specified source type (e.g. point, line, area) octave band sound power levels at selected locations. It predicts noise levels under light down-wind conditions based on hemispherical propagation, atmospheric absorption, ground effects, screening and directivity based on the procedure detailed in International Standard ISO 9613-2:1996 [14].
- 5.2 The ground between the site and the receiver locations has been assumed to be soft although the site itself has been modelled as hard ground. The ground has been modelled as flat and no buildings have been included outside the wellsite in order to present a worst case scenario (i.e. no acoustic screening due to buildings or landform).
- 5.3 The model has been run using a receiver height of 4 metres in order to investigate the noise impact from night-time operations, i.e. at first floor bedroom window level. Noise levels at ground floor or in gardens will therefore be lower than predicted in the model.
- 5.4 The estimated accuracy is stated as ± 3 dB for a mean source / receptor height of up to 5 m and source / propagation separation distance of up to 1 km.
- 5.5 The same noise modelling techniques have been used by RPS on numerous oil and gas sites in the UK and worldwide and there is a high degree of confidence in the model. Validation measurements on a large number of operational drilling rigs has shown a correlation between predicted and measured noise levels of typically ± 1 dB or less under appropriate meteorological conditions.

Noise Modelling Results for Typical Scenarios

- 5.6 The results of the noise modelling for the typical scenarios are summarised in Table 5.1 (drilling and workover). The table includes options for additional mitigation in the form of site screening based on either a 2.5 m, 5 m, 7.5 m or a 10 m high acoustic barrier. In this respect, it should be noted that a 2.5 m high barrier could be formed by placing the storage containers, site offices and welfare facilities around the site boundary, which is the case on most drilling rig layouts. Consequently, it is likely that the 2.5 m high barrier option represents the most likely scenario in terms of a realistic site layout. Likewise, a 5 m high barrier could be formed utilising double stacked containers and so on.

5.7 The tables include a comparison to the appropriate Planning Practice Guidance for Minerals (PPG-M) noise limits of 42 dB $L_{Aeq,1h}$ for 24 hour activities (i.e. drilling, workover and appraisal) and 55 dB $L_{Aeq,1h}$ for daytime only activities (i.e. fracking).

Table 5.1: Noise modelling results for generic scenarios (drilling and workover, compared to 42 dB $L_{Aeq,1h}$ threshold for night-time operations)

	With existing mitigation		With 2.5 m barrier		With 5 m barrier		With 7.5 m barrier		With 10 m barrier	
	200 m	500 m	200 m	500 m	200 m	500 m	200 m	500 m	200 m	500 m
Boldon Rig 92	49	39	46	37	45	36	42	35	41	33
Marriott HH-220	48	38	47	37	42	35	40	33	38	31
DrillTec VDD 370	49	40	48	39	46	37	42	36	40	34
Bentec T-49	48	39	45	36	44	36	42	35	41	33
Bentec T-208	51	42	48	39	47	39	45	37	44	36
BDF Rig 29 – no rotary capability	41	32	39	29	37	28	33	26	30	24
BDF Rig 29 – partial rotary capability	46	37	44	34	42	33	38	31	35	29
BDF Rig 29 – full rotary capability	50	41	48	38	46	37	42	35	39	33

5.8 The results of the noise modelling shows that the PPG-M noise limit can be met at a distance of 200 m with additional screening in place for all drilling and workover rigs except the T-208. However, this does not mean to say that it is not possible to meet the limit for this rig. The primary noise source for the T-208 is the top drive which has been assumed in the model to be running at 130 rpm. If this is reduced to 65 rpm then the noise level reduces by 3 dB, which would mean that the noise limit could be met with a 7.5 m or 10 m high barrier. Furthermore, it is likely that additional noise control measures could be installed to the rig, including the use of a top drive shroud or enclosure. A significant source of noise comes from the top drive motor cooling fan on electric top drives (such as that on the T-208) and it may be possible to fit a silencer to the cooling fan which would reduce noise levels from this source further.

5.9 The above analysis has been based on available drilling rigs without any additional mitigation measures being incorporated. If additional mitigation measures are installed on these rigs it is likely that many of them could be used at distances less than 200 m (e.g. 100 m or less) to the noise sensitive receptor.

5.10 As mentioned previously, experience of monitoring at a number of oil and gas sites in the UK shows that it is often difficult to monitor noise emissions from the drilling rig at the nearest receptor due to interference from extraneous noise sources such as road traffic and aircraft. For example, noise monitoring at Tinker Lane Wellsite (using the HH-220 rig at 630 m to the nearest receptor) and

Preston New Road (using the VDD 370 at 280 m to the nearest receptor) found that noise from drilling was not audible above the baseline ambient sound.

5.11 Nevertheless, noise monitoring at both sites at a location closer to the rig than the noise sensitive receptors confirmed that the planning noise limit was met at both sites. It has therefore been ably demonstrated that the industry can mitigate noise from drilling rigs to within the PPG-M noise thresholds.

5.12 Noise modelling results for hydraulic fracturing are shown in Table 5.2.

Table 5.2: Noise modelling results for generic scenarios (hydraulic fracturing, compared to 55 dB L_{Aeq,1h} threshold for daytime operations)

	With existing mitigation		With 2.5 m barrier		With 5 m barrier		With 7.5 m barrier		With 10 m barrier	
	200 m	500 m	200 m	500 m	200 m	500 m	200 m	500 m	200 m	500 m
Enclosed frac spread (Schlumberger)	63	54	60	50	58	49	55	47	52	45
Enclose frac spread (Halliburton)	60	51	57	47	55	46	52	44	49	42
Unenclosed frac spread (Preese Hall)	64	55	61	51	59	50	56	48	53	46

5.13 For hydraulic fracturing, the noise modelling shows that the PPG-M daytime noise limit can be met at 200 m with a 5 to 7.5 m high acoustic barrier for a small, enclosed fracking spread of the type typically used or planned in the UK. For the higher noise unenclosed fracking spread, the noise modelling shows that a 10 m high barrier may be required to meet the PPG-M limit of 55 dB L_{Aeq,1h}. It should be noted that the noise control fitted to the higher noise unenclosed fracking spread is very limited, meaning that potential gains in noise reduction could be significant.

5.14 It is worth noting that noise monitoring has been ongoing at Preston New Road during the recent hydraulic fracturing activities and no exceedances of the planning noise limit have been identified. Inspection of noise data measured at the nearest noise sensitive receptor shows that noise levels during fracking are broadly similar in level to baseline noise levels when fracking is not taking place, when noise levels are dominated by road traffic and other anthropogenic activity. Noise from hydraulic fracturing was however detected at the monitor near the site boundary. Noise levels caused by activity on site at the nearest noise sensitive receptor are approximately 8 dB lower than at the proxy monitor location. Consequently, it can be concluded that noise from fracking activity was within the PPG-M and planning noise limits for the site.

5.15 This demonstrates that oil and gas developers are able to design and operate fracking spreads which comply with the PPG-M noise limits and well within the 500 m buffer zone proposed (e.g. 280 m in the case of Preston New Road).

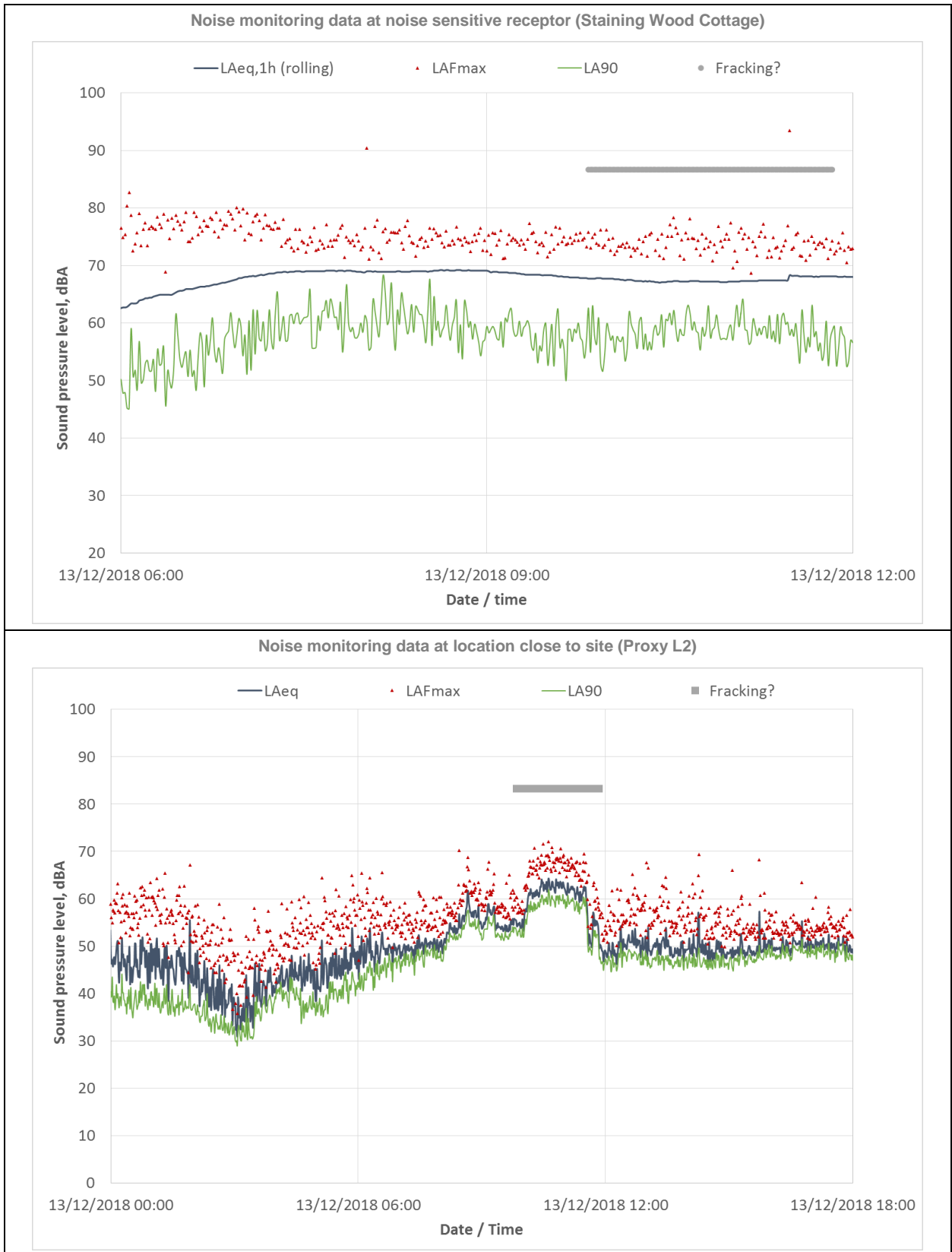

Figure 5.1: Noise monitoring during fracking at Preston New Road

5.16 The results of the noise modelling for flaring are shown in Table 5.3.

Table 5.3: Noise modelling results for generic scenarios (appraisal, compared to 42 dB L_{Aeq,1h} threshold for night-time operations)

	With existing mitigation		With 2.5 m barrier		With 5 m barrier		With 7.5 m barrier		With 10 m barrier	
	200 m	500 m	200 m	500 m	200 m	500 m	200 m	500 m	200 m	500 m
Shrouded ground flare 1.5 mmscf	59	50	59	50	59	50	59	50	55	48
Shrouded ground flare 1 mmscf	55	46	55	46	55	46	55	46	51	44
Enclosed ground flare 1.5 mmscf	50	41	50	41	50	41	45	36	43	36
GBA enclosed ground flare 6 mmscf	41	32	41	32	41	32	36	27	34	27
GBA enclosed ground flare 2 mmscf	35	26	35	26	35	26	30	21	28	21

- 5.17 For flaring, the results show that the choice of the flare type will be important in order ensure that the PPG-M night time noise limit can be met. Since the flare noise levels will be limited by condition at the nearest noise sensitive receptors, it is the duty of operators to design the scheme to comply with these noise limits and to carry out monitoring to demonstrate compliance. In this sense, the approach taken in the oil and gas industry (i.e. selection of equipment to reduce noise using BPM and to comply with any noise limits imposed) is no different to the approach taken in any other industry.
- 5.18 Since the sound power level is related to the flare rates, it is generally possible to “throttle back” the flare rate during the night time. Typically, a 5 dB reduction in sound power can be achieved by halving the flaring rate, although this depends on the design of the flare. This allows further flexibility in flare selection.
- 5.19 Based on extensive experience within the oil and gas industry in the UK over a number of decades (as well as in the landfill industry where waste gas is often flared), it is anticipated that noise control measures are available to reduce noise from oil and gas development to within (or if necessary to below) the PPG-M noise limits for even sites in very close proximity to noise sensitive receptors. Further details on potential in design mitigation are discussed in the following chapter.
- 5.20 It is worth noting that continuous noise monitoring has been ongoing at Preston New Road during recent flaring activities. Analysis of the noise monitoring data shows that there is very little (if any) detectable change in noise level during flaring activity even during the quietest periods of the night (02.00 – 05.00) at a noise monitoring point closer to site than the nearest noise sensitive receptor. (Noise levels due to the site will be approximately 8 dB lower at the nearest noise sensitive receptor than at the noise monitor location.) This robustly demonstrates that oil and gas developers are able to carry out flaring activities at noise levels significantly below the PPG-M noise thresholds,

and also have little or no impact on noise sensitive receptors, at well within the proposed 500 m buffer zone proposed (e.g. 280 m in the case of Preston New Road).

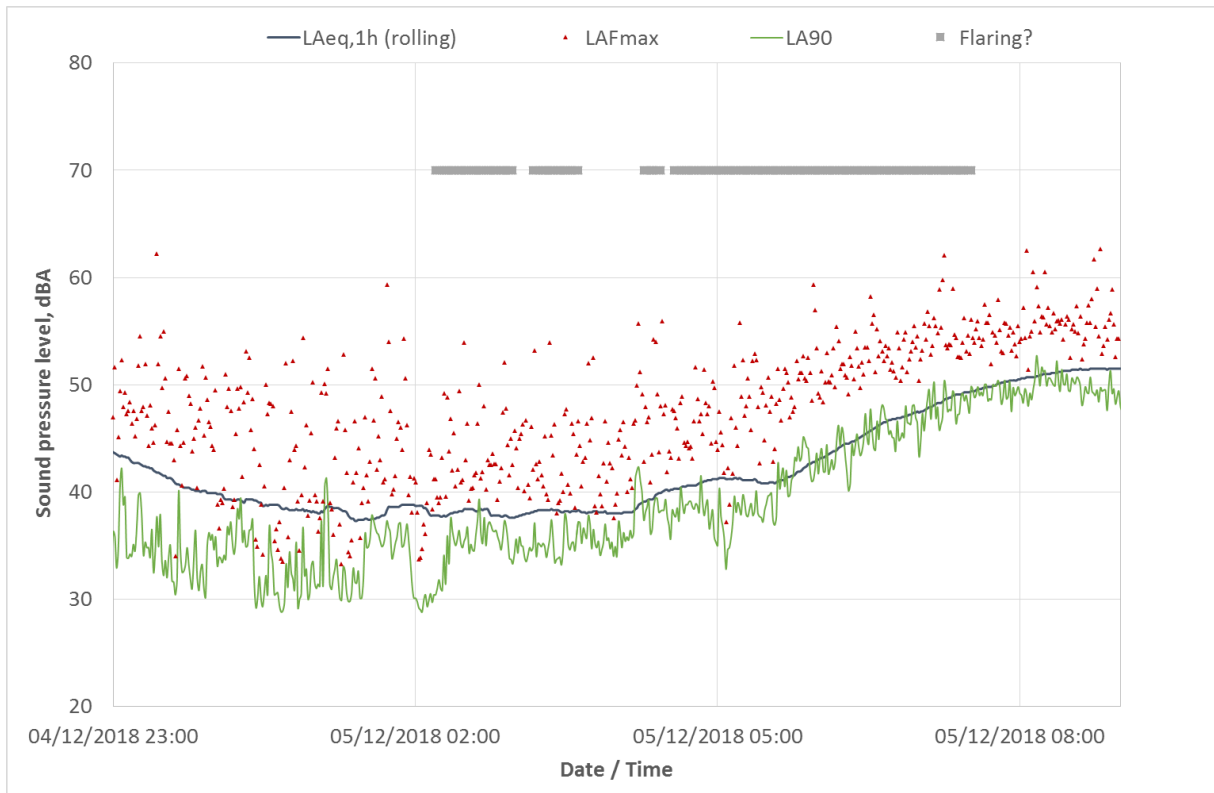

Figure 5.2: Noise monitoring during flaring at Preston New Road

6 Examples of Mitigation

Approach

- 6.1 The approach usually taken for oil and gas developments is to utilise best practicable means to reduce noise levels from the equipment to as low as practicable without incurring an unreasonable burden. Notwithstanding this, it is not always known which equipment will be utilised. Consequently, it is usually difficult to specify the exact noise mitigation measures that would be installed during the planning stage.
- 6.2 This chapter provides details of possible engineering noise control measures for the equipment based on detailed noise measurements on a number of rigs combined with experience of carrying out noise control in the oil and gas industry. These mitigation measures represent the range of typical techniques that could be applied.

Hydraulic Power Unit

- 6.3 The hydraulic power unit (HPU) is a potentially significant source of noise for hydraulic rigs. The majority of acoustic energy from the HPU is typically emitted via the HPU enclosure roof, caused by a combination of structure-borne and airborne transmission paths. A secondary acoustic enclosure can be utilised to reduce its contribution to noise levels. It is also possible to install acoustic lagging to hydraulic pipework if this proves to be a significant source. Based on experience on other rigs, it is anticipated that these mitigation measures should reduce the contribution from the HPU by 5 to 10 dB. An example isometric drawing of an enclosure for a HPU is shown in Figure 6.1.

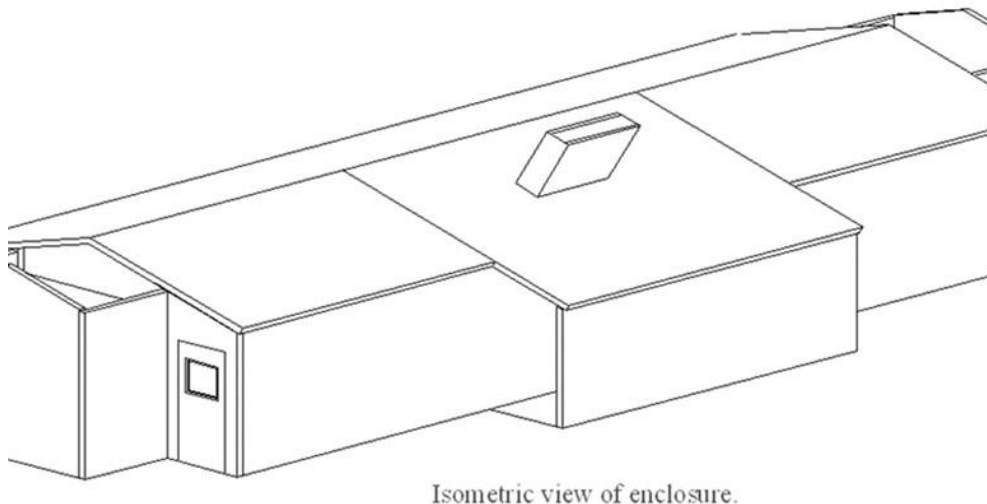

Figure 6.1: Temporary acoustic enclosure for HPU

Mud Pumps

- 6.4 Mud pumps can be either electrically powered or diesel driven and can vary significantly in the degree of noise control fitted as standard.
- 6.5 Mud pumps can be installed in acoustic enclosures (e.g. similar to those shown in Figure 6.2) or screened and fitted with exhaust silencers if diesel driven. An alternative design to individual (packaged) enclosures around each mud pump is to install a larger housing in which all mud pumps can be installed (see Figure 6.3). Based on experience, it is expected that reductions of 10 dB can be achieved through properly designed enclosures and silencers.



Figure 6.2: Mud pump engine enclosure (note exhaust silencers)



Figure 6.3: Example mud pump housing

Generators

- 6.6 Power generators are usually installed in acoustic enclosures. Typically, these incorporate an acoustically absorptive internal lining and possibly an acoustic skirt (if there are significant emissions from the sub-skid). If necessary, depending on the design of generator enclosures, the acoustic performance of existing enclosures can be improved by installation of an additional mass layer between the mineral wool lining and steel outer cladding (mass loaded vinyl has been used with success in the past). The requirement for exhaust silencing will be dependent on the generators and what is already fitted, but generally a double (piggy-backed) silencer arrangement is preferable. Exhaust pipe hangers and supports often utilise resilient inserts to minimise the potential for structure-borne noise. Likewise, the engine itself can be mounted on AV mounts if it is feasible to do so. The air intakes and outlets typically utilise splitter silencers or acoustic louvers, depending on air flow and pressure drop requirements. Using a high specification enclosure, it should be possible to reduce the sound power level of most generators to less than 100 dBA. An example of an enclosure is shown in Figure 6.4



Figure 6.4: Example generator enclosure with high specification exhaust silencers

Shale shakers

- 6.7 Mitigation for shale shakers could be in the form of either a full enclosure or by using local screening around the shakers. Up to 10 dB reduction in noise from the shale shakers can typically be achieved for a full enclosure and 3 to 5 dB reduction for localised screening. The choice of

screening or enclosure will depend upon the location and elevation of the shale shakers on the rig chosen as well as their noise level (for example, on some rigs the shale shakers may already be screened by the rig structure).

Centrifuge

- 6.8 Centrifuges can be a significant noise source if they are not enclosed. For noise sensitive applications is recommended that the centrifuge is installed in an acoustic enclosure with an internal acoustically absorptive lining and suitable AV mounts to prevent structure-borne noise. An example enclosure is shown in Figure 6.5.

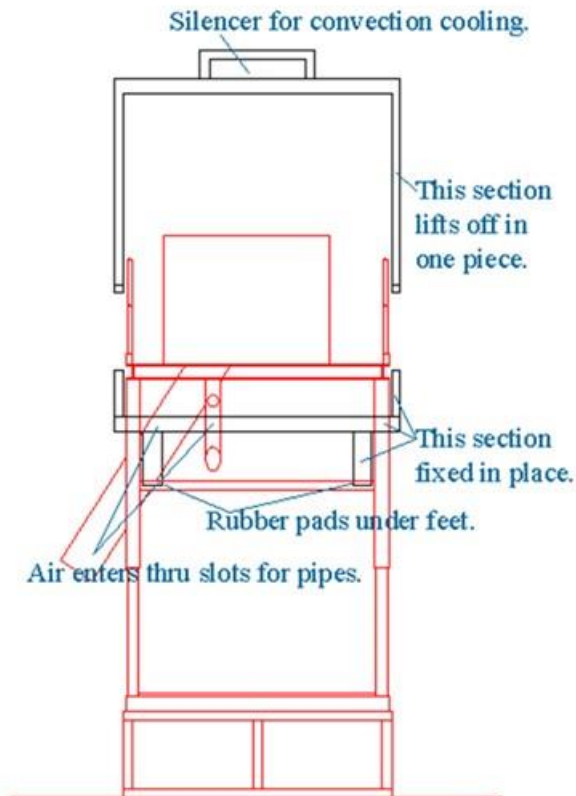

Figure 6.5: Example centrifuge enclosure

Acoustic screening

- 6.9 Depending on the rig chosen, it may be possible to erect an acoustic screen around some parts of the rig. This could be in the form of a bespoke acoustic screen (e.g. Figure 6.6), close-boarded wooden fencing or stacked containers (e.g. Figure 6.7, showing triple stacked containers). Some in-site screening could be provided, for example, by erecting site stores and offices so that they are between the rig equipment and the residential receptors.



Figure 6.6: Example demountable acoustic barrier



Figure 6.7: Example barrier constructed from containers

Draw-works

- 6.10 Although not a continuous noise source, the draw-works is used for hoisting new sections of drill pipe via the travelling block once each section has been drilled, depending on the rig design (draw-works are not usually used on hydraulic rigs, for example). It is also used for tripping. During operation of the draw-works, the top drive is not normally operational (instead the rotary table is used). Although the draw-works are usually located on the drill floor (which can sometimes be acoustically screened), the sound power level can be relatively high on some rigs which can mean that this source of noise could intermittently be significant. It is generally recommended that, depending on the characteristics of the chosen rig and technical / safety constraints, an acoustic enclosure is fitted around the draw-works. This would typically include an acoustically lined “sleeve” for the draw-works cables to penetrate.

Top drive

- 6.11 Many drilling rig top drives can be fitted with an acoustic enclosure. It may be possible to fit a silencer to the cooling fan on electric top drives which would reduce noise levels from this source further. An example top drive enclosure is shown in Figure 6.8.



Figure 6.8: Example top drive enclosure

Full rig enclosure

- 6.12 If drilling is required in very close proximity to residential dwellings (e.g. <100 m), it may be necessary to install the entire rig in an enclosure. Such an enclosure has been utilised at one site in the UK in the past. This particular enclosure was installed around the Larchford HH-220 rig and commissioning tests showed that it reduced noise from the top drive by 19 dB.
- 6.13 There are, however, several drawbacks to the use of full enclosures including:
- Impacts to visual amenity (the HH-220 was a singles rig but a much larger enclosure would be required for a doubles or triples rig);
 - Safety concerns with respect to potential gas entrapment;
 - Safety concerns with respect to emergency escape for personnel on the rig floor;
 - Cost and timescale implications; and
 - Additional traffic impacts due to transportation of the enclosure to site.
- 6.14 Accordingly, full enclosures are only used as a very last resort due to the significant safety implications resulting from their use.

Fracking pumps

- 6.15 Although the fracking industry in the UK is in its infancy, there have already been significant developments in reducing noise from fracking pumps. There are two frac spreads currently available which utilise enclosed pumps, significantly reducing noise emissions compared to unenclosed pumps. Examples are shown in Figure 6.9.



Figure 6.9: Example frac pump enclosure

Flaring

- 6.16 Noise from flaring operations during appraisal is similar in nature to noise from flaring used on landfill sites in the UK. Consequently, the potential noise control mechanisms are similar for the oil and gas industry as used on landfill sites.

- 6.17 Combustion noise in flares is a combination of two main mechanisms. Firstly, there is the jet noise due to the gas flowing through the orifice(s) and then noise produced from the combustion process. It is usually the former of these that dominates. The level of noise and frequency content is also affected by the flare nozzle – for example, the frequency content is a direct function of the dimensions of the orifices. Large reductions in sound emission can be attained by utilising a low noise flare tip but this needs to be balanced against other factors such as flare emissions, efficiency and flow handling capability.
- 6.18 Orifice plates can be used upstream of the flare in order to reduce pressure at the tip, resulting in reduced turbulence and jet noise. The design of such mitigation systems is necessarily specific to the design of the flare but significant reductions can be achieved using this technique.
- 6.19 Another important factor is the height of the flare. Ground flares will be less able to propagate than flares at a height. Furthermore, it may be possible to utilise screening around a ground flare in order to reduce noise. It is therefore recommended that ground flares are utilised combined with an acoustic screen (i.e. a shrouded flare).
- 6.20 Where it is practicable to do so (taking into account other factors such as environmental emissions), an enclosed flare is usually the preferred choice to reduce noise levels. An example enclosed ground flare is shown in Figure 6.10.

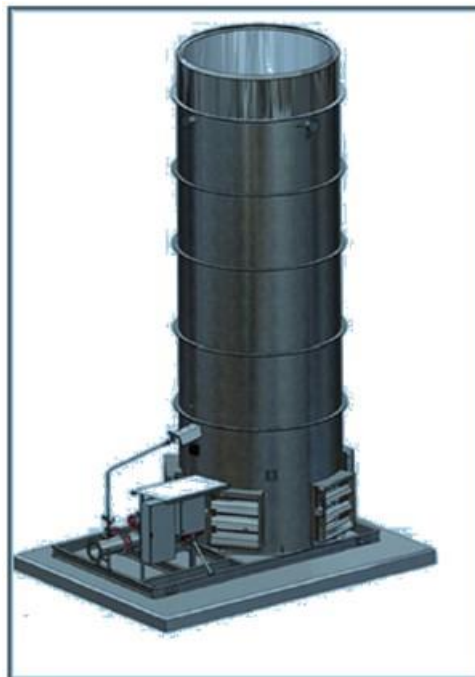

Figure 6.10: Example enclosed ground flare

- 6.21 Alternatively, it may be possible to utilise an enclosed combustor rather than a flare, although there may be technical difficulties due to gas emission compliance requirements meaning that this might not be feasible. (Choice of flare types is very closely regulated by the Environment Agency.)

6.22 In general, the primary source of mitigation for flaring is equipment selection. In this respect, operators will typically select the flare system based upon the site specific noise limit in combination with operational and other emission factors.

Innovation

6.23 The oil and gas industry, both onshore and offshore, across the world continues to innovate and introduce new technology to meet greater environmental standards or to increase economic productivity.

6.24 Equipment chosen for use on a specific site will be selected according to the specific geology and other 'physical' characteristics of site, but it must also meet the site-specific environmental requirements to comply with planning policy and regulation. A balance must always be struck with respect to the wider costs and impacts associated with adopting a method or technique against the environmental benefit or dis-benefit. Decisions must be made on a site by site basis with respect to geography, local environment and the technical characteristics of the site.

6.25 Drilling rigs have advanced significantly from an acoustic perspective over the last two decades. There are a number of advances including:

- use of induction braking systems or disk brakes rather than noisier drum brakes which were traditionally used (i.e. to prevent brake squeal);
- use of inherently quieter electrically and hydraulically powered rigs rather than old style diesel rigs;
- use of inherently quieter electrically powered mud pumps rather than the older design diesel powered units;
- use of automated pipe handling systems, virtually eliminating the impact noise associated with traditional pipe handling methods;
- use of acoustic enclosures for potentially noisy equipment such as mud pumps, generators, centrifuges, hydraulic power units, top drives etc.;
- specification of high-performance silencers and other noise reduction measures; and
- use of different drill bits and down-hole (mud driven) motors has recently been used to reduce the torque at the top drive and reduce the noise footprint of a rig. This must be balanced against the technical requirements for drilling so will not be applicable in all circumstances.

6.26 As expectations with respect to noise continue to increase both in Europe and worldwide, the manufacturers continue to refine designs to make equipment quieter. For example, some top drive manufacturers now use helical gears to top drives to reduce noise compared to straight gear meshing. Similar improvements are taking place throughout the industry including use of enclosed fracking pumps and new low noise flare designs.

- 6.27 There is potential to utilise different methods to reduce noise by design for example by using alternative methods for powering the rigs. As an example, some sites in Europe operate using grid power rather than rely on mobile generators, although this requires a suitable grid connection on site (which might not be practicable on many sites, particularly in rural areas).
- 6.28 On the basis of the above, it can be concluded that not only has the industry been actively developing quieter technology for many years, but that there is currently significant effort within the industry to improve further.

7 Noise Characteristics (Tonality, Impulsivity and Low Frequency Noise)

Tonality

- 7.1 Noise from modern drilling rigs is usually characterised as being broadband and constant in character. Whilst it is possible that there could be some sources of tonal noise on any particular rig (e.g. the centrifuge), these are usually mitigated at source. In any case, any tonal noise sources are usually masked by noise from other sources on the rig such that there are no prominent tones at noise sensitive receptors. There are not usually any tonal sources of noise on fracking spreads or flares. Consequently, it is not considered that tonality is an issue for normal oil and gas exploration and appraisal operations.

Impulsivity

- 7.2 The use of automated pipe handling on modern rigs has greatly reduced the likelihood of impulsive noise occurring. Consequently, impulsivity is not considered to be a significant issue affecting modern drilling rigs.

Low Frequency Noise

- 7.3 There are potential sources of low frequency noise for oil and gas activities such as diesel engines (generators, fracking pumps) and shale shakers. The issues with respect to diesel driven equipment is not significantly different to issues facing any other industry where mobile power generation plant is required, such as mobile generators on a construction site or use of water drainage pumps. Standard mitigation techniques are used to reduce these noise sources such that low frequency noise does not become problematic, including the use of acoustic enclosures and high specification reactive silencers.
- 7.4 Within the oil and gas industry, the primary cause of low frequency noise complaints has been due to the use of large gas turbines on operational sites or from large furnaces (for example as used in refineries). These sources of noise are not applicable to oil and gas exploration and appraisal.

Use of 'C' Weighting

- 7.5 The term 'A' weighting implies a measurement made using a filter with a standardised frequency response which approximates the frequency response of the human ear at relatively low levels of noise. The resulting level, expressed in 'A' weighted decibels, or dBA, is widely used in noise standards, regulations and criteria throughout the world.
- 7.6 The 'C' weighting network weights a signal in a manner similar to an "equal loudness" contour at high sound pressure levels. It is typically used with the peak response of a sound level meter to assess potential hearing damage at higher noise levels due to peak pressure. The use of 'C'

weighting has fallen out of favour because the weightings do not correlate well with subjective tests. One reason for this lack of correlation between subjective tests and 'C' weighting measurements is because the equal loudness contours were based on experiments which used pure tones and most common sounds are not pure tones, but very complex signals made up of a combination of many different tones and broadband sound.

- 7.7 The difference between 'C' and 'A' weightings has been used in the past as an indication of the amount of low frequency energy in sound. This method was fairly common decades ago before the prevalence of sound level meters with octave (or third-octave) band capability. Typically, if the difference between the 'C' and 'A' weighted level is more than 20 dB, then this indicates that there is potential for a low frequency noise problem. However, this method fell out of favour because the dBC - dBA difference cannot determine whether any low frequency sounds are audible, let alone result in annoyance. Consequently, it is not considered to be a suitable metric for assessing low frequency sound in the context of environmental noise if used in isolation. A more robust approach would be to analyse the octave band frequency spectra.

8 Response to Joint Plan Authorities' Supplementary Note to Inspector

- 8.1 In their supplementary note for the Inspector, the Joint Authorities state that they “*consider that the sound levels from potential hydrocarbon developments generally should not exceed existing background sound levels by more than 10dB(A) for the daytime or evening time periods or the maximum daytime or evening limit specified within the minerals guidance note at anytime, whichever is lowest. During the night time period noise levels should not exceed 42 dB(A) $L_{Aeq,1h}$ (free field).*”
- 8.2 The Joint Authorities interpretation of the PPG-M is not correct, especially the use of the term “*whichever is lowest*”. Splitting the requirements from the PPG-M for daytime noise into steps it requires the following:
- 1 Mineral planning authorities should **aim** to establish a noise limit that does not exceed the background noise level by more than 10 dB during normal working hours.
 - 2 Where this will be difficult without imposing **unreasonable burdens** on the operator, the limit set should be **as near that level as practicable**; and
 - 3 In any event, the total noise from the operations should not exceed 55 dB $L_{Aeq,1h}$ (free field).
- 8.3 In other words, whilst the PPG-M encourages the lower noise level as a threshold where it is achievable and does not impose an unreasonable burden, it specifically provides for noise limits up to a maximum of 55 dB $L_{Aeq,1h}$ where the lower threshold would be unreasonable.
- 8.4 Furthermore, the PPG-M states that “*Care should be taken, however, to avoid any of these suggested values being implemented as fixed thresholds as specific circumstances may justify some small variation being allowed.*” In other words, the PPG-M allows some variation even in the maximum thresholds. This could be applicable, for example, in locations where the ambient noise levels without development already exceed the noise thresholds contained in the PPG-M. Conversely, it could be argued that lower noise limits are preferable in areas with particularly low baseline noise levels (subject to the caveat on imposing an unreasonable burden on the operator).
- 8.5 In any case, the higher (daytime) noise limits are usually much higher than required for the majority of the phases of development for oil and gas sites. Operations such as drilling and flaring take place on a 24/7 basis and do not vary significantly in the noise produced whether it is day or night. Consequently, it is the night-time noise limit of 42 dBA which will be the limiting factor for these phases. The higher (daytime) noise limits are typically only required for very short term activities such as hydraulic fracturing.
- 8.6 It is worth noting that the industry's approach to noise assessments is to reduce noise to as low as is practicable by using best practicable means. In this respect, the industry's approach is already

in line with the intended purpose of the PPG-M to minimise and mitigate noise taking into account the burden on the operator.

- 8.7 The Joint Authorities provide a very basic analysis of noise levels from drilling operations in their supplementary note. Whilst the sound power levels and predicted noise levels at noise sensitive receptors are not out of step with reality, they have failed to appreciate the raft of mitigation measures which are available for use at sites which are particularly noise sensitive.
- 8.8 This report provides a much more detailed analysis of noise data for different noise sources, noise levels at noise sensitive receptors and mitigation measures which can be deployed when required. This report has demonstrated that the PPG-M noise limits can be achieved using existing and well established techniques even at a distance of 200 m or less, as long as equipment is selected and mitigated in the appropriate manner. It is considered that this much more detailed analysis, using actual data and more advanced modelling techniques, provides a significantly more robust evidence base than the Joint Authorities high level analysis. Indeed, the Joint Authorities admit within their report that they do not fully understand the reasons for differences in the sound power level for different drilling rigs operating in different locations (indeed, different countries).
- 8.9 The authorities comment in relation to multiple drilling rigs operating at once is not relevant to typical oil and gas operations. It is highly unlikely that, for example, it would be possible to fit two drilling rigs on a well pad, even if there was ever a desire to do so. Development phases within the oil and gas industry tend to take place sequentially as opposed to concurrently. Even if concurrent operations were required, the operator would be required to provide mitigation to ensure that the relevant noise limits were met.
- 8.10 The Authorities' conclusion that "the proposed 500 m distance represents a distance within which it is appropriate for policy to say it is unlikely that adequate mitigation can be provided" is therefore incorrect. This report as demonstrated that the PPG-M noise limits can be met using existing and well established techniques even at a distance of 200 m or less. In this respect, it is important to understand that the noise modelling undertaken in this report is based on current drilling rigs with their existing mitigation. It is possible that further mitigation could be installed on many of these rigs (and others) if required.
- 8.11 Based on the above, and the contents of this report, it is considered that the opposite conclusion should be reached – i.e. that a 500 m buffer zone is unnecessary and unreasonable. Instead, it is recommended that the policies contained in the PPG-M should be applied (i.e. by setting appropriate noise limits taking account of the baseline noise environment and applying mitigation in order to meet those noise limits).

9 Summary and Conclusions

- 9.1 The approach currently used in England for assessing noise from oil and gas development is based on the PPG-M. Use of the PPG-M as the primary planning policy guidance for use in assessing noise from oil and gas sites has been extensively tested and confirmed by a number of recent public inquiry decisions.
- 9.2 The PPG-M specifically recognises that minerals extraction sites are limited in where they can be situated due to the location of the natural resource. In this respect, the PPG-M does not include any recommendations for establishing a buffer zone around a site, instead taking the approach of setting suggested noise thresholds. Typically, noise limits are set by the Minerals Planning Authority as part of any planning permission, taking into account the baseline noise environment. These conditions provide appropriate protection against sleep disturbance and loss of amenity.
- 9.3 It is these noise limit as defined in the PPG-M that provide protection for residential premises, not the distance between the site and receiver per se. This approach allows sufficient flexibility to the operator recognising the advice in the PPG-M in relation to minerals needing to be worked where they are found.
- 9.4 It is the operator's responsibility to select equipment and to design mitigation which will meet the site specific noise limit. Noise levels can then be monitored throughout the development to ensure that noise limits are not breached, providing additional assurance to the Minerals Planning Authority. Noise monitoring at a number of oil and gas developments has confirmed that the industry is able to comply with the PPG-M limits at distances of significantly less than 500 m.
- 9.5 If the PPG-M had intended to protect health and amenity by means of a buffer zone then it would have explicitly said so. However, use of buffer zones is not mentioned in the PPG-M. Indeed, the Ministerial statement specifically advises that buffer zones should not be imposed.
- 9.6 There are numerous examples of consented oil and gas developments operating at distances of less than 500 m from the nearest noise sensitive receptor. The oil and gas industry has demonstrated over a number of decades that they are able to mitigate noise from operations to meet the PPG-M thresholds at these closer distances.
- 9.7 There are numerous ways of reducing noise from oil and gas development – some of which have been described within this report. Furthermore, innovation and product development will mean that noise levels from new equipment will continue to fall.
- 9.8 The Joint Authorities provided a very basic analysis of noise from drilling operations in their supplementary note but failed to appreciate the raft of mitigation measures which are available. This report provides a more robust analysis of potential noise from oil and gas development and the mitigation measures that are available to reduce noise further if required.
- 9.9 It is therefore concluded that the use of a 500 m buffer zone for oil and gas development is not consistent with national planning policy, is unreasonable and demonstrably unnecessary.

Appendices

Appendix A: Detailed Noise Data for Drilling Rigs

Boldon Drilling Rig 92

- A.1 One of the example rigs is the Boldon Drilling Rig 92, shown in Figure 9.1, which has an electric top drive. The rig has been used previously at Wytch Farm in Dorset and has been fitted with noise mitigation measures in order to operate in noise sensitive environments.



Figure 9.1: Photo of Boldon Rig 92

- A.2 Although RPS has not undertaken a noise survey on the rig, sound power level data has been made available for the purposes of this assessment, as shown in Table 9.1.

Table 9.1: Boldon Rig 92 source sound power levels used in assessment, dB re 1 pW

Item	Overall, dBA	Linear octave band centre frequency, Hz								
		31.5	63	125	250	500	1k	2k	4k	8k
Top drive- with enclosure	95	96	104	105	93	92	89	87	82	72
Top drive- without enclosure	99	93	98	99	97	95	94	92	86	78
Top drive blower	96	94	97	97	93	93	90	89	82	73
Mud pump enclosure	102	49	98	98	100	100	97	94	91	87
Generator (per generator)	100	108	111	108	101	96	93	90	87	92

Marriott Drillmec HH-220

- A.3 The Drillmec HH-220 rig is operated by Marriott Drilling. The HH-220 rig is hydraulically operated and is erected using its own hydraulic pistons. Pipe handling is automated and computer controlled, and as a consequence there is significantly reduced manual handling of drill pipes, virtually eliminating the impact noise associated with more traditional pipe handling methods. The top drive is hydraulically powered. There is no brake drum as on a conventional drilling rig, and hence there is no characteristic brake drum “squeal”.
- A.4 A photo of the Marriott HH-220 rig is shown in Figure 9.2.



Figure 9.2: Photo of Marriott HH-220 rig

- A.5 In addition to the drilling rig trailer there are three packaged generators (of which two units are normally in operation) as well as other equipment including: mud pumps, shale shakers, centrifuges, a mud mixing units and a hydraulic power pack (HPU).
- A.6 Mitigation measures installed on the HH-220 rig include:
- Hydraulic operated rig with automated pipe handling to reduce pipe handling noise;
 - Enclosed shale shakers;
 - Acoustically enclosed top drive;
 - Acoustically enclosed generators with high specification exhaust silencers; and
 - Acoustically enclosed HPU.
- A.7 Sound power level data for the rig was obtained from noise surveys carried out by RPS whilst drilling at Tinker Lane Wellsite in December 2018. Measurements were carried out using the sound intensity scanning methodology. The sound power levels were determined by measuring sound intensity levels (by scanning a microphone probe over each element) and integrating over the radiating area. In general, measuring sound intensity to determine sound power provides more

accurate predictions than measuring sound pressure due to the ability to minimise/reject off axis/extraneous noise. Furthermore, the ability to measure more accurately in the near-field (compared to sound pressure level measurements) means that there is no requirement to include empirical near-field corrections in the sound power calculations.

- A.8 A summary of the Marriott HH-220 rig noise data utilised to build the noise model is shown in Table 9.2 as overall A-weighted and linear octave band sound power levels.

Table 9.2: Octave band sound power level data for Marriott HH-220 rig, dB re 1 pW

Item	Overall, dBA	Linear octave band sound power level, dB re 1 pW								
		31.5	63	125	250	500	1k	2k	4k	8k
Generator enclosure	95	108	106	109	93	89	85	79	71	68
Generator exhaust	100	104	106	113	100	92	87	87	89	84
Top Drive (80-90 rpm)	92	-	95	96	95	89	85	82	78	71
Mud pump (per pump, unenclosed)	104	101	104	105	103	100	97	96	95	89
Mud pumps enclosure (2 of 3 pumps operating) - Enclosed	98	109	102	93	97	96	90	90	89	78
Shale shakers	84	100	92	84	81	81	79	76	72	68
Sand screen	81	109	88	81	78	78	77	73	69	67
Hydraulic Power Unit (Enclosed)	89	99	90	92	94	89	75	72	73	66
Rig trailer	92	92	86	85	100	88	76	69	66	57
Centrifuge (enclosed)	89	83	85	98	85	86	84	77	71	67

- A.9 Notably, the opportunity was taken to measure the mud pumps with and without an enclosure fitted. The results show that the sound power level for the mud pumps reduced by approximately 9 dB (from 107 dBA for 2 pumps to 98 dBA for 2 pumps) once a mud pump enclosure was fitted.

DrillTec VDD 370

- A.10 The DrillTec VDD 370 rig is a hydraulic rig with automated pipe handling. The DrillTec rig is hydraulically operated and is erected using its own hydraulic pistons. Pipe handling is automated and computer controlled, and as a consequence there is significantly reduced manual handling of drill pipes, virtually eliminating the impact noise associated with more traditional pipe handling methods. The top drive is hydraulically powered. There is no brake drum as on a conventional drilling rig, and hence there is no characteristic brake drum “squeal”.

- A.11 A photo of the rig is shown in Figure 9.3.



Figure 9.3: Photo of DrillTec VDD 370 rig

- A.12 In addition to the drilling rig trailer there are four main packaged generators as well as other equipment including: mud pumps, shale shakers, centrifuges, mud mixing units and a hydraulic power pack (HPU).
- A.13 Mitigation measures installed on the DrillTec rig include:
- Hydraulic operated rig with automated pipe handling to reduce pipe handling noise;
 - Acoustic enclosure fitted around top drive;
 - Centrifuge enclosed within rig structure;
 - Acoustically enclosed generators with high specification exhaust silencers; and
 - Acoustically enclosed HPU.
- A.14 A noise survey was undertaken by RPS whilst the rig was drilling a horizontal well at Preston New Road, Lancashire, in June 2018. The sound power levels were determined by measuring sound intensity levels (by scanning a microphone probe over each element) and integrating over the radiating area. A summary of the DrillTec VDD 370 rig noise data utilised to build the noise model is shown in Table 9.3 as overall A-weighted and linear octave band sound power levels.

Table 9.3: Octave band sound power level data for DrillTec VDD 370 rig, dB re 1 pW

Item	Overall, dBA	Linear octave band sound power level, dB re 1 pW								
		31.5	63	125	250	500	1k	2k	4k	8k
Generator 1	93	103	110	104	89	88	83	83	78	73
Generator 1 Exhaust	96	94	116	106	100	86	84	80	74	66
Generator 2	98	100	120	107	100	91	89	83	80	75
Generator 2 Exhaust	95	98	116	106	100	85	82	78	75	68
Generator 4	91	103	106	102	91	87	83	80	74	71
Generator 4 Exhaust	94	90	108	108	98	84	80	73	69	60
Mud Pump Drive Motor	100	119	109	102	99	98	94	91	90	84
Mud Pump	90	102	93	91	93	87	84	82	76	73
Main HPU	97	104	106	98	102	94	87	85	84	77
Auxiliary HPU	95	105	110	97	99	93	82	82	81	67
Shale Shakers	102	127	112	109	103	100	94	92	89	87
Agitators	96	102	101	97	96	93	92	89	84	77
Centrifuge (Enclosed)	92	107	96	92	95	93	69	77	74	71
Top Drive (Enclosed)	93	106	102	99	98	89	83	79	76	69

Bentec T-49

- A.15 Another example rig is the KCA Deutag T-49 Bentec E-1250-DC rig, shown in Figure 9.6, which is 43.4 m high with an electric top drive.



Figure 9.4 Photo of Bentec T-49 rig

- A.16 Measurements were carried out on the T-49 rig in July 2015 at Moersaatsenweg, Vierpolders (near Brielle), Netherlands. The rig was operating using the electrical grid supply and therefore the generators were not being used at the time. However, it was possible to run up one of the rig generators for testing purposes. The rig was drilling ahead during the survey with all mud pumps, shale shakers and centrifuges in operation.
- A.17 The sound power level levels were determined by measuring sound intensity and sound pressure levels (by scanning a microphone probe over each element or by measuring at a specified distance from each source) and integrating over the radiating area.
- A.18 The source sound power levels for the T-49 rig are presented in Table 9.4.

Table 9.4 Octave band sound power level data for rig T-49, dB re 1 pW

Item	Overall, dBA	Linear octave band sound power level, dB re 1 pW								
		31.5	63	125	250	500	1k	2k	4k	8k
Generator air intake	87	98	100	99	90	80	79	72	70	68
Generator enclosure sides	96	112	104	103	98	93	90	86	80	72
Generator radiator	99	104	104	105	102	95	93	90	84	75
Generator exhaust (per generator)	91	100	98	99	94	87	85	80	74	67
Generator enclosure roof	94	108	101	99	96	91	88	84	78	71
Mud pumps	107	108	111	113	111	102	99	96	91	85
Shale shakers	104	119	108	105	101	101	99	94	94	93
Top drive (24,000 kNm)	101	109	98	98	100	99	96	93	87	82
Pipe handler	94	111	99	97	96	90	89	83	79	76
Centrifuge	96	108	100	99	96	96	90	86	82	76

A.19 In addition to the detailed noise measurement survey on the rig, a noise logger was set up on the site boundary for model validation purposes. The noise model for the T4-9 drilling rig predicts a sound pressure level of 65 dBA at a location equivalent to the measurement position for the noise logger (i.e. 55 m from the rig structure) where a sound pressure level of 64 dBA was measured. This difference is demonstrated in Figure 9.5 which shows a comparison between the measured and calculated octave band sound pressure levels for the measured and predicted cases. It can be seen that there is very close correlation between the noise model and the measured noise levels at the site boundary.

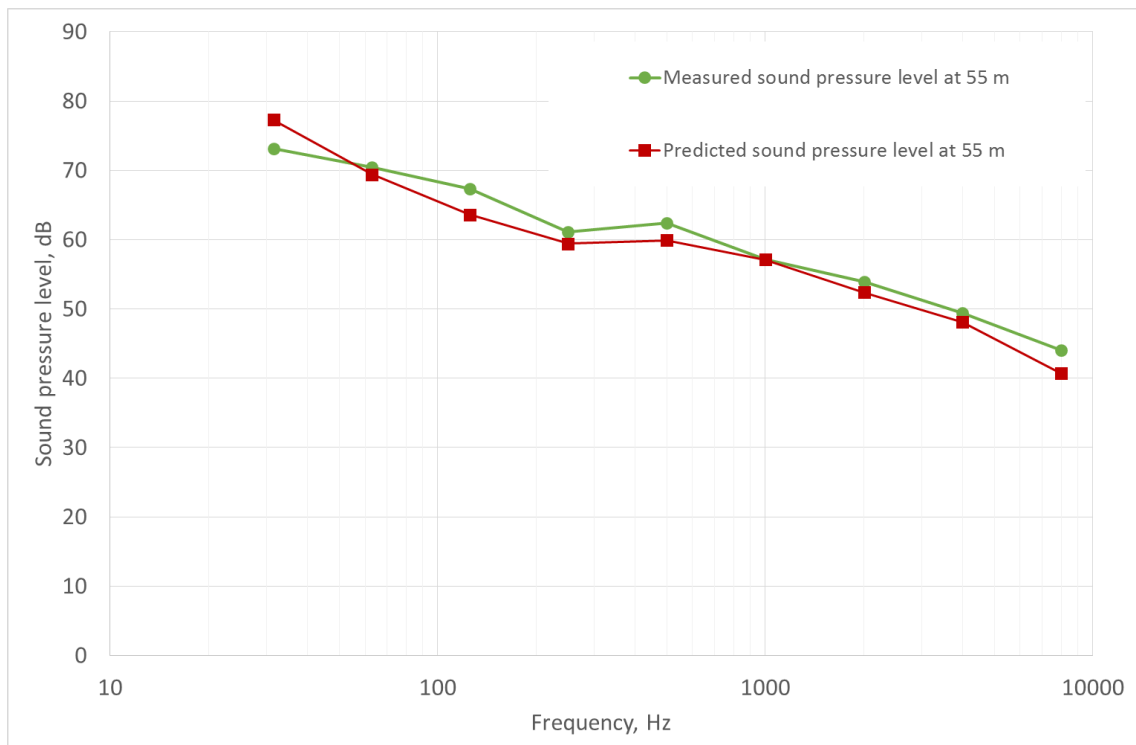

Figure 9.5 Comparison of measured and predicted noise levels from T49 rig at 55 m

Bentec T-208

A.20 Another example rig is the Bentec T-208, shown in Figure 9.6, which is a 53.3 m high rig with an electric top drive.



Figure 9.6 Photo of Bentec T-208 rig

A.21 Although RPS has not undertaken noise measurements on this rig, detailed noise measurements have been undertaken on the rig by German consultancy Kötter Consulting Engineers GmbH & Co (report no. 212363-02.01). Measurements were conducted on the rig with two different top drive speeds of 65 and 130 rpm in order to determine the potential sound power level under a range of drilling conditions.

Table 9.5 Octave band sound power level data for T-208, dB re 1 pW

Item	Overall, dBA	Linear octave band sound power level, dB re 1 pW								
		31.5	63	125	250	500	1k	2k	4k	8k
Wirth TPK 1600 mud pump motor	103	98	101	101	97	94	92	101	93	81
Wirth TPK 1600 mud pump (remaining components without motor)	95	97	103	100	98	93	87	83	79	73
Shale shaker with enclosure	94	114	96	92	88	90	89	86	85	83
Pumps, agitators and tanks	93	93	92	91	90	89	89	86	82	75
Centrifuge unit	97	96	99	94	96	95	90	89	89	79
Power control unit (inc coolers)	94	94	89	93	96	90	89	85	81	77

Item	Overall, dBA	Linear octave band sound power level, dB re 1 pW								
		31.5	63	125	250	500	1k	2k	4k	8k
Top drive (65 rpm)	100	94	95	94	99	98	95	90	86	87
Top drive (130 rpm)	103	94	94	95	100	101	97	96	88	86

A.22 No measurement results were presented for the generators (it is understood that the rig was operating using power from the electric grid). However, it is expected that the sound power level for the generators will be similar to those on other rigs of a similar power and size.

References

- 1 Department for Environment, Food and Rural Affairs. Noise Policy Statement for England. Defra. 2010.
- 2 Ministry of Housing, Communities & Local Government. National Planning Policy Framework: HSMO. July 2018.
- 3 Department for Communities and Local Government. National Planning Practice Guidance
- 4 Department for Communities & Local Government. Planning Practice Guidance: Minerals. HMSO. 2014. <http://planningguidance.planningportal.gov.uk/>
- 5 European Centre for Environment and Health. Night Noise Guidelines (NNGL) for Europe. World Health Organisation. 2009.
- 6 Berglund, B. et al. Guidelines for Community Noise. World Health Organisation. 2000.
- 7 Skinner C and Grimwood C. (2002). The National Noise Incidence Study 2000/2001 (United Kingdom): Volume 1 – Noise Levels. BRE report 206344f.
- 8 Environmental Noise Guidelines for the European Region. World Health Organisation. 2018.
- 9 British Standards Institution. British Standard 4142:2014. Methods for rating and assessing industrial and commercial sound.
- 10 Report to the Secretary of State for Communities and Local Government by Wendy McKay LLB Solicitor (Non-practising) an Inspector appointed by the Secretary of State for Communities and Local Government. 2016.
- 11 Appeal Decision by Stephen Roscoe BEng MSc CEng MICE an Inspector appointed by the Secretary of State for Communities and Local Government. 2018.
- 12 Appeal Decision by Elizabeth Hill BSc(Hons), BPhil, MRTPI an Inspector appointed by the Secretary of State. 2018.
- 13 Appeal Decisions by Mr K L Williams BA, MA, MRTPI an Inspector appointed by the Secretary of State for Communities and Local Government. 2018.
- 14 ISO. International Standard ISO 9613-2:1996. Acoustics - Attenuation of sound during propagation outdoors - Part 2: General method of calculation.